

# CN Series Multi-function Counter User's Manual



## Features:

- ⊙ Max counting speed can reach 10KCPS
- ⊙ Coefficient be settable among 0.00001~999999
- ⊙ Universal input. "NPN" or "PNP" is selected by software
- ⊙ At most two loops of alarm for counting/length counting one loop of alarm for batch counting
- ⊙ Meter / Yard switch function
- ⊙ With RS485 communication function ,standard Modbus RTU protocol
- ⊙ Can be applied to the counting/controlling in the field of light industry、machinery、packing、food industry ,etc.

## Safe Caution

※ For your safety, please read the below content carefully before you use the meter !

Please comply with the below important points:

- ⚠ Warning An accident may happen if the operation does not comply with the instruction.
- ⚠ Notice An operation that does not comply with the instruction may lead to product damage.

※ The instruction of the symbol in the manual is as below:

- ⚠ An accident danger may happen in a special condition.

## Warning

1. A safety protection equipment must be installed or please contact with us for the relative information if the product is used under the circumstance such as nuclear control, medical treatment equipment ,automobile, train, airplane, aviation, entertainment or safety equipment, etc. Otherwise, it may cause serious loss, fire or person injury.
2. Apanel must be installed, otherwise it may cause creepage (leakage).
3. Do not touch wire connectors when the power is on, otherwise you may get an electric shock.
4. Do not dismantle or modify the product, If you have to do so, please contact with us first. Otherwise it may cause electric shock and fire.
5. Please check the connection number while you connect the power supply wire or input signal, otherwise it may cause fire.

## Caution

1. This product cannot be used outdoors. Otherwise the working life of the product will become shorter, or an electric shock accident may happen.
2. When you connect wire to the power input connector or signal input connectors, the moment of the No.20AWG (0.50 mm<sup>2</sup>) screw tweaked to the connector is 0.74n.m-0.9n.m. Otherwise the connectors may be damaged or get fire.
3. Please comply with the rated specifications. Otherwise it may cause fire after the working life of the product becomes shorter.
4. Do not use water or oil base cleaner to clean the product. Otherwise it may cause electric shock or fire, and damage the product.
5. This product should be avoid working under the circumstance that is flammable, explosive, moist, under sunshine, heat radiation and vibration.
6. In this unit it must not have dust or deposit, otherwise it may cause fire or mechanical malfunction.
7. Do not use gasoline, chemical solvent to clean the cover of the product because such solvent can damage it. Please use some soft cloth with water or alcohol to clean the plastic cover.

## 1.Code Illustration

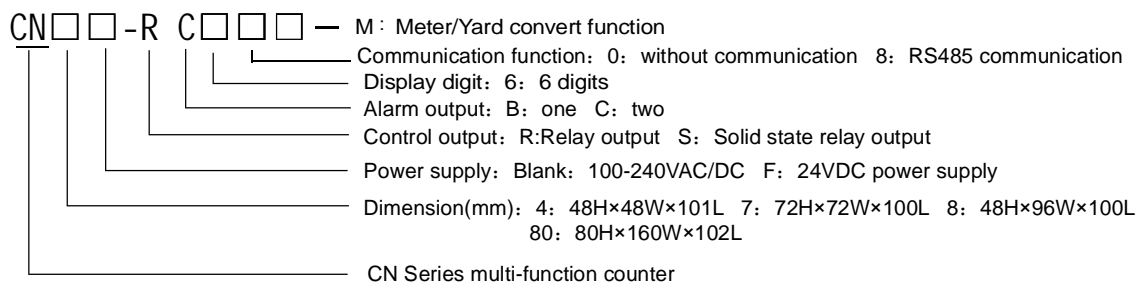

\*24V power supply could be ordered

## 2.Ordering Code

No.	Code	Panel size(mm)	Display digit	Alarm output	Batch output	Communication
1	CN4-RC60	48H×48W	6	2	No batch	NO
2	CN7-RC60	72H×72W	6	2	1 Relay	NO
3	CN7-RC68	72H×72W	6	2	1 Relay	RS485
4	CN8-RC60	48H×96W	6	2	1 Relay	NO
5	CN8-RC68	48H×96W	6	2	1 Relay	RS485
6	CN80-RC60	80H×160W	6	2	1 Relay	NO
7	CN80-RC68	80H×160W	6	2	1 Relay	RS485

## 3.Technical Parameter

Series	CN	
Display	Dual rows with 6-digit LED	
Power supply	100-240V AC/DC	
Allowable voltage floating range	90-110% of the rated voltage (AC )	
Input frequency of INA,INB	1Hz,30Hz,1KHz,5KHz,10KHz can be selectable	
Input pulse width	INA,INHIBIT,RESET,BATCH RESET,1ms or 20ms can be selected	
Input	Voltage input:Input impedance is 5.4KΩ,"H": 5-30VDC "L": 0-2VDC Non-voltage input: Max short-circuit impedance : 1KΩ, Residual voltage: Max 2V DC Open-circuit impedance: Max 100KΩ	
One-shot output	10/50/100/200/500/1000/2000/5000ms	
Control output	Contacts capacity	NO:250VAC 3A impedance NC: 250VAC 2A impedance
	SSR capacity	Max 30V DC , Max 100mA
Memory time	10 years	
External sensor power	12VDC±10% below 100mA	
Working temperature	-10℃~50℃ (Non-freezing)	
Store temperature	-25℃~65℃ (Non-freezing)	
Ambient Humidity	35-85%RH	
Insulation resistance	Min 100MΩ (at 500VDC)	
Dielectric strength	2000V AC 50/60Hz 1 minute	
Interference(AC Power)	±2kV interferenced by square wave generator (Pulse width:1us)	
Vibration	Mechanical	Amplitude: 0.75mm Frequency : 10 to 55Hz each direction of X, Y, Z for 1 hour
	Malfunction	Amplitude: 0.5mm Frequency : 10 to 55Hz each direction of X, Y, Z for 10 min
Shock	Mechanical	300/S (About: 30G) each direction of X,Y,Z for 3 times
	Malfunction	100/S (About: 10G) each direction of X,Y,Z for 3 times
Life Span	Mechanical	Above 10,000,000 times
	Electric	Above100,000 times (NO:250VAC 3A load NC:250VAC 2A load)

## 4.Panel Indication

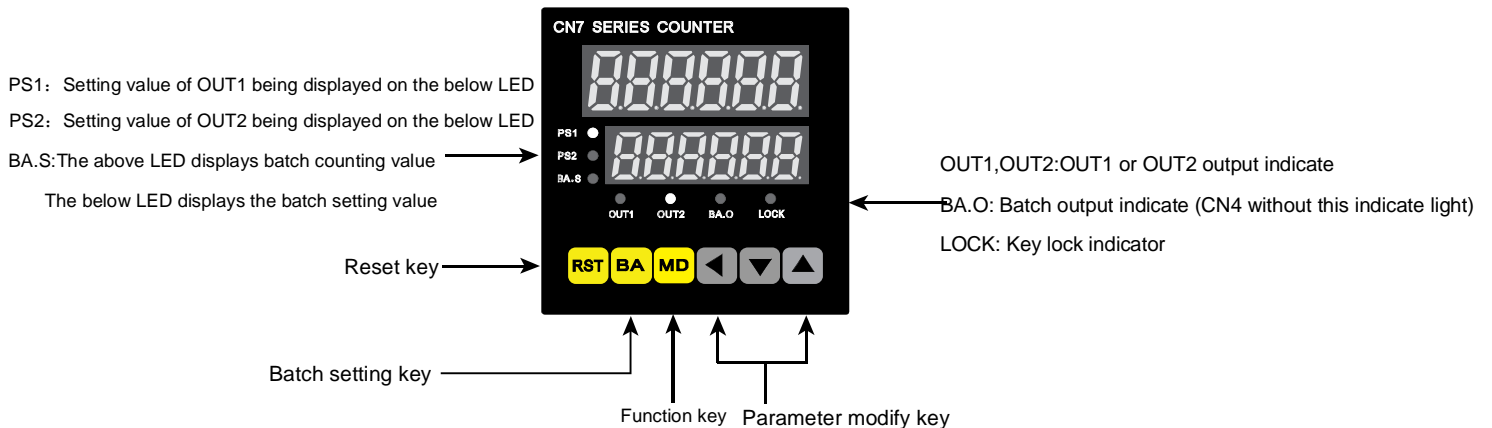

## 5.Operation Sequency

1.How to change the value from 175 to 180

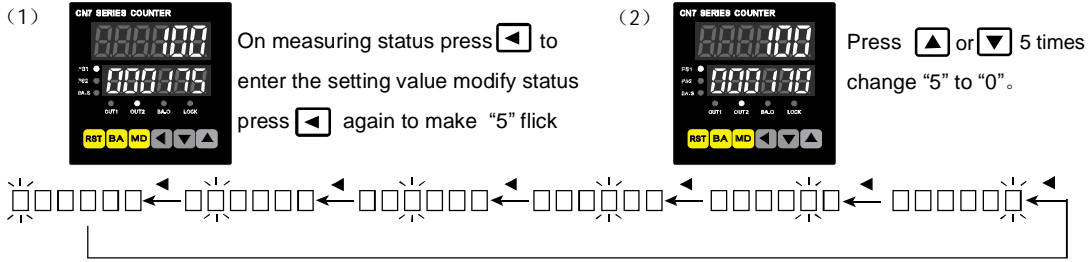

∴ Under measuring status press enter the setting value modify status . and the selected data will flick from right to left circularly

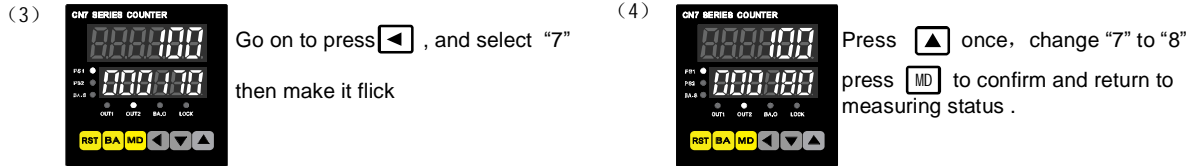

## 6.Batch counting & batch setting value

6.1. Batch output action

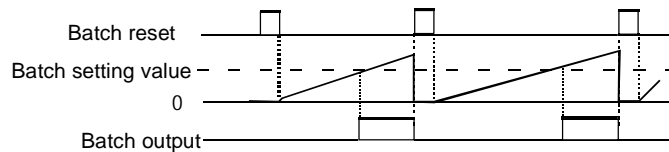

### ◆ Batch counting

Batch counting value is up counting , only external reset signal can clear it to zero .  
If batch counting value beyond 999999, it will reset automatically and start counting again .  
The first batch counting value are not influenced by key and external reset signal .

(1)Batch counting under counting mode

When the counting alarm output No. equals to the batch setting value , batch alarm will output .  
When batch control output is used , the intervals of the up counting time should more than 10ms .

### ◆ Output action for batch

If the batch output is ON , it will keep the ON status till the batch reset signal comes .  
If the batch output is ON,and the meter power off then on power again ,batch output should keep "ON" status till external reset signal comes.

6.2. Modifying for the batch setting value

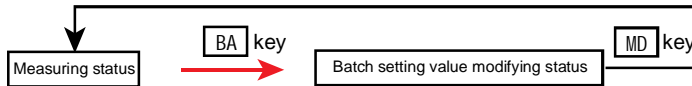

### ◆ Under measuring status , press key to enter the batch setting value modifying status

The way of modifying the batch setting value is the same as that of the counting setting value .Press to select the digit which needs to be modified and make it flick . Press to modify the value . Press to confirm and return to measuring status .  
When the batch setting value modifying status , the above LED will display the present batch counting value .

### ◆ If enter the batch value setting status , and without any operation for more than 60s , it will return to measuring status automatically .

## 7.Coefficient Function

Eg:Pulse No.-- P is the pulse quantity when the rotary encoder running a circle ,L is the measured length,coeffecient value = L / Pulse No. of one circle, It represents the actual length of a pulse .

Controlling length of the counter and rotary encoder

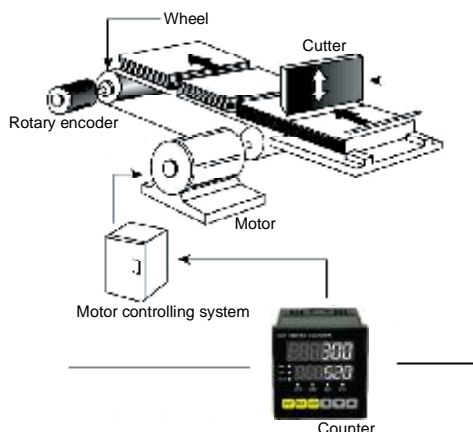

$$\text{Coefficient value} = \frac{\pi \times \text{Diameter}(D)}{\text{Pulse quantity of the encoder rotating a circle}}$$

$$= \frac{3.1416 \times 22}{1000}$$

$$= 0.069\text{mm/pul se}$$

Under function setting mode ,change the coefficient value to 0.069 in the coefficient setting menu

The diameter of the wheel which connects the rotary coder is 22mm, when the rotary encoder rotates a circle ,there will be 1000 pcs pulses

## 8. Setting for the key locking

Key lock is to avoid mistake operation of the key  
 LoFF (LOCK OFF): Cancel key lock  
 LoC.1 (LOCK LEVEL1): Lock RST key  
 LoC.2 (LOCK LEVEL2): Lock ▼, ▲ and ◀ key  
 LoC.3 (LOCK LEVEL3): Lock RST, ◀, ▲ and ▼

## 9. Setting for the Counting Mode

Setting mode	Selection ( ▼, ▲ )
Input mode (In)	U → d → U d-R → Ud-b → Ud-C If the output mode is S T D, input mode can only select Ud-A B C
Max counting speed (CPS)	1 → 30 → 1K → 5K → 10K Counting speed means the max input frequency of INA and INB, suppose it to 5K, if the input frequency beyond 5K, then measuring will be not accuracy.
Output mode (OUT)	※ Up or Down input mode F → n → C → r → P → Q → R ※ Up/Down - A、B、C input mode F → n → C → r → P → Q → R → S → t → d
OUT2 output time (OUT2)	10 → 50 → 100 → 200 → 500 → 1000 → 2000 → 5000 Unit:ms
OUT1 output time (OUT1)	10 → 50 → 100 → 200 → 500 → 1000 → 2000 → 5000 → Hold Unit:ms
Input logic (SIG)	Select with ▲, ▼ : PnP or nPn input mode
Min reset time (rSt)	1 ↔ 20 Min width of RESET signal (Unit:ms)
Decimal point (dP)	----- * ----- * ----- *
Coefficient value (SCL)	◀ key : Move the flick digit RST key: Modify the decimal point of coefficient value ▼、▲ key : Modify the coefficient value Coefficient value range: 0.00001-999999
Start value (St)	◀ key : Move the flick digit ▼、▲ key : change the start value Start value setting range: -99999-999999 Start value: The displayed value after reset automatically or manually
Counting value storage (dREA)	CLR → r EC CLR: Power off The counting value reset r EC: Power off The counting value be saved
Baud rate (BAUD)	4800 ↔ 9600 Baud rate be selectable :4800 or 9600
Address of the meter (Add)	Communication address can be settable : 1-247
Lock key (LoCK)	LoFF → LoC.1 → LoC.2 → LoC.3

# 10.Action Mode Switch

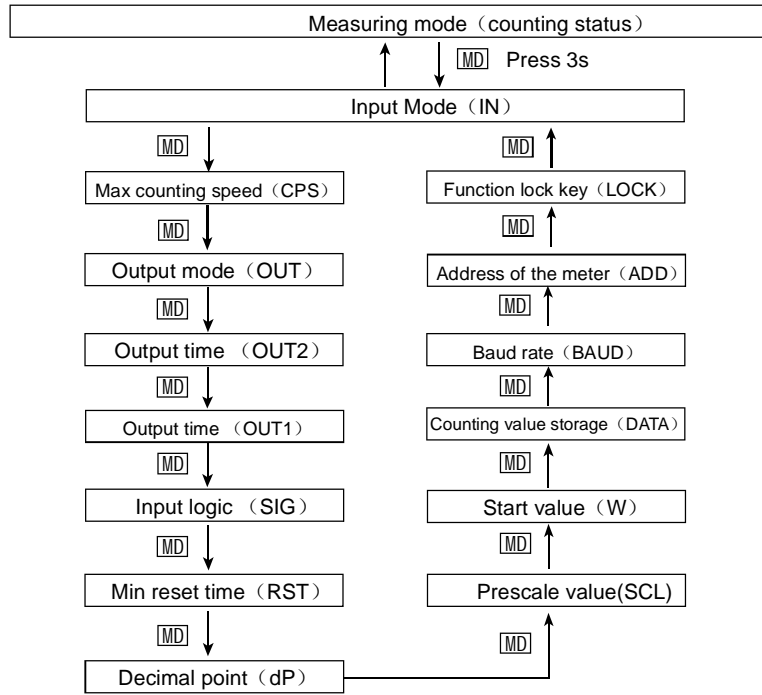

- ※ In function setting mode ,if without any operation for more than 60s,the counter will return to measuring mode .
- ※ If select mode F or mode N ,when counting value reaches the preset value, the output will maintain, so there is no "output time of OUT2" menu in function setting mode
- ※ If output mode set to S、T、D , input mode can only select Ud-A、B、C .If want to select Up/Down input mode, then output mode can just select the mode except for the mode S、T、D .
- ※ If select mode D as output mode,when the counting frequency beyond 1Kcps,considering the responding time of a relay may cause abnormal output action, so SSR output will be better .
- ※ When Max counting speed is 5kcps or 10kcps, if change the mode to mode"D", counting speed will select 1KCPS automatically .
- ※ In function setting mode, external input signal can also be recognized . when exit the function setting mode, display value and output will reset automatically.
- ※ When the start value (W) exceeds the setting value of OUT1 and OUT2 , there will be no output of OUT1 and OUT2 .

# 11.Input action mode of the counter

※ (A) : Beyond the width of the min signal (B) : Beyond the half of the min signal width

Input mode	Counting graph	Remark
U (Up)		INA: Be used as counting input INB: Be used as control input INB=L: Input pulse to INA, then counting up INB=H: Forbid INA to count
		INA: Be used as control input INB: Be used as counting input INA=H: Input pulse to INB, then counting up INA=L: Forbid INB to count
D (Down)		INA: Be used as counting input INB: Be used as control input INB=L: Input pulse to INA, then counting down INB=H: Forbid INA to count
		INA: Be used as control input INB: Be used as counting input INA=H: Input pulse to INB, then counting down INA=L: Forbid INB to count

Input mode	Counting graph	Remark
Ud-a (Up/Down-A) Order input		INA: Be used as counting input INB: Be used as control input INB=L: Input pulse to INA, then counting up INB=H: Input pulse to INA, then counting down
Ud-b (Up/Down-B) Single input		Input pulse to INA, then counting up Input pulse to INB, then counting down
Ud-c Phase difference input		INA lead ahead INB, then counting up INA lag behind INB, then counting down Phase difference input (be applied to rotary encoder)

※ When use phase A and phase B of the rotary encoder, please take INA and INB as input ends, and select Ud-C input mode.

Sign	Input type	Voltage input (PNP)	Contacts input (NPN)
	H		5-30VDC
L		0-2VDC	Open circuit

## 12. Output mode

※ stare value  $\bar{c} = 0$

		One-shot output (OUT1 output)	One-shot output (OUT2 output)	Hold output	Output at the same time
	Input mode				Action for counting /timing when it reaches to the setted value
		Up	Down	Up/DownA, B, C	
F		Display keeps up or down, output maintain till reset signal input			
N		Both display and output maintain till reset signal input.			
C		Display vale return to the beginning status automatically, output won't return to the beginning until it reaches to the setted delay time.  (Output action is repeated)			
R		Both display value and output maintain till it reaches to the setted delay time then return to the beginning status.  (Output action is repeated)			

	Input mode			Action for counting /timing when it reaches to the setted value
	Up	Down	Up/DownA, B, C	
K				Display value keeps up or down till reset signal input ,output won't return to the beginning status until it reaches the setted delay time .  (Output action is repeated)
P				Display value maintains till the delay time output , then display the value of next round.(Counting/Timing of next round starts from the beginning value during the delay time )  (Output action is repeated)
Q				Display value keep up or down during the output delay time, when it comes to the setted delay time,both the display value and output will return to the beginning status.  (Output action is repeated)
A				Display value and output of OUT1 maintain till reset signal input .OUT2 return to the beginning status when it reaches to the output delay time .  (Output action is repeated)

	Up/DownA,B,C	Action
S		OUT1 and OUT2 meet the following requirements keep " ON " statu :  Display value $\geq$ Setting value1 Display value $\geq$ Setting value2
T		When display value < Preset value1, OUT1 keep " ON " status  When display value < Preset value 2 , OUT2 keep "oFF" status .
D		Only when display value =Setting value (preset value1 or 2),OUT1 and OUT2 keep "ON" status .  When counting speed set to 1kcps , should use SSR output mode .

### 13.Connecting Drawing

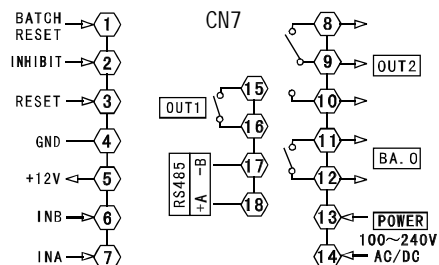
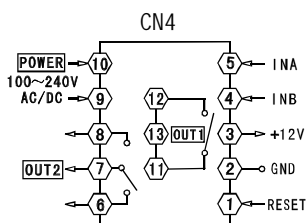

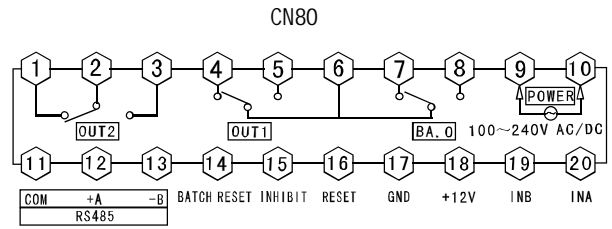
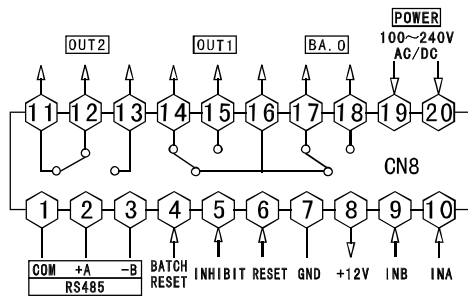

Note: Please subject to the connecting drawing on the actual product if any changes

## 14. Input Connecting

### 1. Input logic: No-voltage input (NPN)

- (1) Solid state relay input
- Standard sensor: NPN output sensor

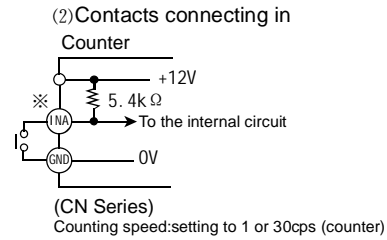
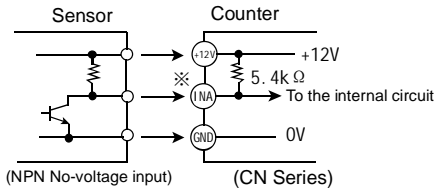

### 2. Input logic: voltage input (PNP)

- (1) Solid state relay input
- Standard sensor: PNP output sensor

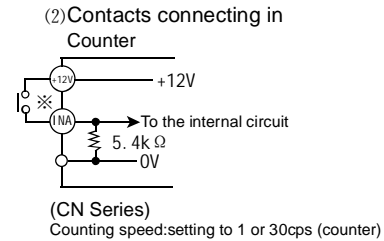
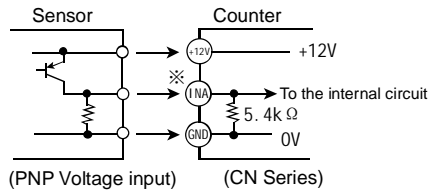

## 15. Output Connecting

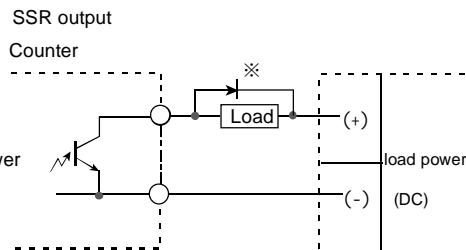
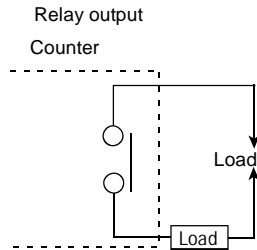

### SSR output

1. Adopt proper load and power, output of the SSR can't be too large, capacity (Within 30VDC, 100mA)
2. Make sure the power supply not connected inversally
3. When adopt inductive load (such as relay), Filter circuit (such as diode, rheostat) should be connected between the two ends of the load.

## 16. Dimension & Mounting Size

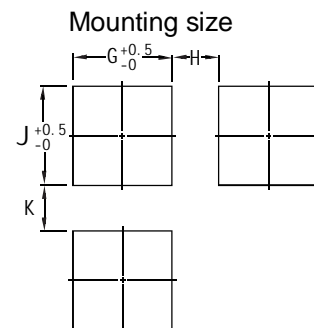
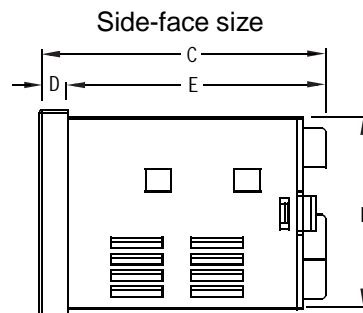
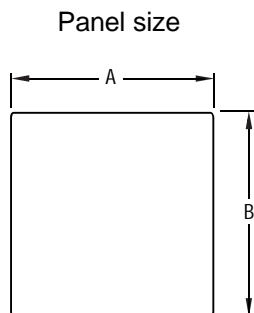

Code	A	B	C	D	E	F	G	H (Minimum)	J	K (Minimum)
CN4 : (48*48)	48	48	101	10	91	45	45.5	25	45.5	25
CN7 : (72*72)	72	72	100	10	90	67.5	68	25	68	25
CN8 : (48*96)	96	48	100	6	94	45	91.5	25	45.5	25
CN80: (160*80)	160	80	102	10	92	76	154	30	76.5	30
Remark	Unit: (mm) tolerance +0.5% (The particular indicated are not included)									



# Communication Protocol of the Counter

## 1. Type and Format of the Communication Data

This series adopt Asynchronous communication interface (SCI) , the electrical level for the interface comply with the standard RS485 protocol .

The data frame format of MODBUS RTU Protocol is : one start bit , 8 data bit , without check , one stop bit .Baud rate of communication transfer data is 4800bit/s or 9600bits/s

### Data frame format

start bit	data bit	check bit	stop bit
1	8	without	1

## 2. Transfer Process of the Communication Message

When the communication order be sent to the slave unit from the master unit , if the slave unit receive order which coincides with the address sent from the master unit be checked CRC checking and order format without error ,then slave unit will carry out the corresponding operation and feedback the running result .

### 2-1. Address of the meter ( 1 byte )

It is included in the address area , the range is :1-247 . The master unit selects the slave unit by input the slave unit address to order address area . When the slave unit feedback a data , it put its own address to the address area of the feeded back message , so that the master unit will learn which slave unit responded . ( Each address of the equipment in a bus must be unique )

### 2-2 . Function code ( 1 byte )

It is included in the function code of the message . When be sent to slave unit from the master unit , the function code will tell the slave unit which operations should be carried out . When slave unit responses , function code will instruct normal response or error (abnormal response). About normal response , the slave unit just feedback the received function code . When it is abnormal response , the slave unit will set the highest bit of received function code to 1 , then feedback .

### Definition of the function code

Function code	Definition	Operation
0x03	Read register	Read the data of single or several register
0x10	Write multi-register	Write n pcs of 32-bit binary data into n pcs of successive registers

### 2-3. Data area

It is included data area of the message , length of the data is different with function code .

## 3. Order Format of Master Unit & Feedback Message Format from Slave Unit

### 3-1. Read Multi-register

For example: Master unit send order reading the data of OUT2 alarm value register

Oder format	Master unit send order		
Address area	Meter address	0X01	
Function area	Function code	0X03	
Data area	Address of the begin register	High bit	0X00
		Low bit	0X05
	Quantity of read register	High bit	0X00
		Low bit	0X01
error detect area	CRC checking code	Low bit	0X94
		High bit	0X0B

Message format	Feedback message from slave unit		
Address area	Meter address	0X01	
Function area	Function code	0X03	
Data area	Byte No. of the data		0X04
	OUT2 register data ( 32-digit data , low bit in front , high bit at behind)	Low bit 1	0XC0
		Low bit 2	0X5A
		High bit 1	0XFB
		High bit 2	0X34
	error detect area	CRC checking code	Low byte
High byte			0XC7

Note: The above example is to read the order and format of a single register data .When need to read multiple registers at a time , it only need to fix the first address of the register and the needing read register No.s ( read/write order from low bit to high bit ) , then can read successive register data of multiple address . When feedback a data , low bit of it will be in front , and high bit lists behind .

### 3-2. Write Multi-register

For example: Master unit sends an order writing 1000.000 into OUT2 alarm register of the slave un

Order format	Master unit sends order			
Address area	Meter address	0X01		
Function area	Function code	0X10		
Data area	Address of the begin register	High byte	0X00	
		Low byte	0X05	
	Read quantity of the register	High byte	0X00	
		Low byte	0X01	
	Byte No.s of the write data		0X04	
	OUT2 register data read to write in (32-digit , low bit in front , high bit at behind )	Low bit 1	0X40	
		Low bit 2	0X42	
High bit 1		0X0F		
High bit 2		0X00		
error detect area	CRC checking code	Low byte	0X83	
		High byte	0X87	

message format	Feedback message from slave unit			
Address area	Meter address	0X01		
Function area	Function code	0X10		
Data area	Address of the begin register	High byte	0X00	
		Low byte	0X05	
	Quantity of write register	High byte	0X00	
		Low byte	0X01	
error detect area	CRC checking code	Low byte	0X11	
		High byte	0XC8	

#### 4. Communication error shooting

When the meter detects an error excepted for CRC checking code , it will feedback an error message to master unit .The slave unit set the high bit of the received function code to 1, then feedback the meter address and error code as error message

##### 4-1. Error code format feedback from slave unit

Address code	Function code (highest position)	Erro code	CRC checking code low byte	CRC checking code low byte
one byte	one byte	one byte	one byte	one byte

##### 4-2.Erro code

0X01	Function code error	Received function code can not be supported by the meter
0X02	Register address error	Received register address exceeds the range of the meter register address
0X03	Quantity of register error	Received register quantity exceeds register quantity of the meter
0X04	Data value error	Received data value exceeds the data range of the corresponding address

#### 5.Parameter address of the meter

No.	Register address	Register name	Data type	Value range	Function	Remark
0	0x0001	Counting value PV	long	----	R	Reserve 3 decimal point
1	0x0002	Batch counting value BV	Unsigned long	----	R	
2	0x0003	Alarm status	Unsigned long	----	R	
3	0x0004	OUT1 alarm value (PS1)	Unsigned long	1~999999000	R/W	Reserve 3 decimal point
4	0x0005	OUT2 alarm value (PS2)	Unsigned long	1~999999000	R/W	Reserve 3 decimal point
5	0x0006	BA.O alarm value (BA.S)	Unsigned long	1~999999	R/W	
6	0x0007	scale coefficient SCL	Unsigned long	0.00001-9999.99	R/W	Reserve 5 decimal point
7	0x0008	Start value W	long	-99999-999999	R/W	Reserve 3 decimal point
8	0x0009	Meter status 1	Unsigned long	----	R/W	
9	0x000A	Meter status 2	Unsigned long	----	R/W	
10	0x000B	Meter status 3	Unsigned long	----	R/W	
11	0x000C	Meter status 4	Unsigned long	----	R/W	

\*PV , PS1 , PS2 are defaulted to reserve 3 decimal point . The actual value=feedback data or write data/1000.If the register feedback data PV =1 ,actual PV value =0.001 .Similarly write 100000 into PS2 register. Actual setting value of OUT2 (PS2)=1000.0000 ( Effective display digit of the decimal point can be set by the DP menu of the meter )

6. Alarm status (address:0x0003)

Bit31	Bit30	Bit29	Bit28	Bit27	Bit26	Bit25	Bit24	Bit23	Bit22	Bit21	Bit20	Bit19	Bit18	Bit17	Bit16
Reservation								BA.O alarm output flag							
Bit15	Bit14	Bit13	Bit12	Bit11	Bit10	Bit9	Bit8	Bit7	Bit6	Bit5	Bit4	Bit3	Bit2	Bit1	Bit0
OUT2 alarm output flag								OUT1 alarm output flag							

- 6-1、Bit0-Bit7      OUT1 alarm output flag: 0x00: OUT1 no alarm output,      0x01 : OUT1 has alarm output  
 6-2、Bit8-Bit15    OUT2 alarm output flag: 0x00: OUT2 no alarm output,      0x01 : OUT2 has alarm output  
 6-3、Bit16-Bit23    BA.O alarm output flag: 0x00: BA.O no alarm output,      0x01 : BA.O has alarm output

7. Register of the meter status 1 (address:0x0009)

Bit31	Bit30	Bit29	Bit28	Bit27	Bit26	Bit25	Bit24	Bit23	Bit22	Bit21	Bit20	Bit19	Bit18	Bit17	Bit16
OUT2 output delay time setting unit								OUT1 output delay time setting unit							
Bit15	Bit14	Bit13	Bit12	Bit11	Bit10	Bit9	Bit8	Bit7	Bit6	Bit5	Bit4	Bit3	Bit2	Bit1	Bit0
OUT output mode setting unit								SIG logic level selection for input terminal							

7-1、Bit0-Bit7: SIG input logic level select unit (value range 0x00- 0x01)

Bit0-Bit7=0x00: NPN input mode, signal input by connecting the internal 7.4K resistance to the 12V auxiliary power supply

Bit0-Bit7=0x01: PNP input mode, signal input by connecting the internal 5.4K resistance to the public ground terminal .

7-2、Bit8-Bit15: OUT output mode select unit of the meter (value range be determined the present status)

Bit8—Bit15 output mode							
Bit8—Bit15	output mode	Bit8—Bit15	output mode	Bit8—Bit15	output mode	Bit8—Bit15	output mode
0x00	F	0x01	N	0x02	C	0x03	R
0x04	K	0x05	P	0x06	Q	0x07	A
0x08	S	0x09	T	0x0a	D		

Remark:Before set output mode to mode D,please make sure CP ≤ 1KHZ , or it will feedback an error code

7-3、Bit16—Bit31: OUT1 ,OUT2 alarm output delay time select unit (value range : 0x00- 0x08 )

Bit16 — Bit23 corresponding to OUT1 output delay time				Bit24 — Bit31 corresponding to OUT2 output delay time			
Bit16—Bit23	Delay time	Bit16—Bit23	Delay time	Bit24—Bit31	Delay time	Bit24—Bit31	Delay time
0x00	10mS	0x01	50mS	0x00	10mS	0x01	50mS
0x02	100mS	0x03	200mS	0x02	100mS	0x03	200mS
0x04	500mS	0x05	1000mS	0x04	500mS	0x05	1000mS
0x06	2000mS	0x07	5000mS	0x06	2000mS	0x07	5000mS
0x08	HOLD						

Remark:Bit16—Bit23 value range (0-8)

Remark:Bit24—Bit31 value range (0-7)

8. Register of the meter status 2 (address:0x000A)

Bit31	Bit30	Bit29	Bit28	Bit27	Bit26	Bit25	Bit24	Bit23	Bit22	Bit21	Bit20	Bit19	Bit18	Bit17	Bit16
IN input mode select								DATA power off data save							
Bit15	Bit14	Bit13	Bit12	Bit11	Bit10	Bit9	Bit8	Bit7	Bit6	Bit5	Bit4	Bit3	Bit2	Bit1	Bit0
DP display decimal point select								RST effective pulse width selection of input controlling signal							

8-1、Bit0-Bit7: RST effective pulse width selection of input controlling signal (value range:0x00- 0x01)

Bit0-Bit7=0x00: Effective pulse width of input controlling signal is 20 ms .

Bit0-Bit7=0x01 :Effective pulse width of input controlling signal is 1 ms .

8-2、Bit8-Bit15: DP display decimal point select (value range:0x00 -0x03)

Bit8—Bit15	Decimal point	Bit8—Bit15	Decimal point	Bit8—Bit15	Decimal point	Bit8—Bit15	Decimal point
0x00	without	0x01	1	0x02	2	0x03	3

8-3、Bit16-Bit23: DATA power off data save select (value range: 0x00 - 0x01) .

Bit16-Bit23=0x00: The present counting value clear to zero when power off .

Bit16 -Bit23=0x01: Save the present counting value when power off, if power on again the counting value begins with the saved value.

8-4、Bit24-Bit31: IN input mode select (value range : 0x00 - 0x04)

Bit24—Bit31	Input mode	Bit24—Bit31	Input mode	Bit24—Bit31	Input mode	Bit24—Bit31	Input mode
0x00	U	0x01	D	0x02	UD-A	0x03	UD-B
0x04	UD-C						

## 9.Register of the meter status 3 (address: 0x000B)

Bit31	Bit30	Bit29	Bit28	Bit27	Bit26	Bit25	Bit24	Bit23	Bit22	Bit21	Bit20	Bit19	Bit18	Bit17	Bit16
CPS high limit select unit of the counting frequency								ADD communication address setting unit of the meter							
Bit15	Bit14	Bit13	Bit12	Bit11	Bit10	Bit9	Bit8	Bit7	Bit6	Bit5	Bit4	Bit3	Bit2	Bit1	Bit0
BAUD communication baud rate setting unit								LOCK key lock level select unit							

9-1、Bit0-Bit7: LOCK key lock level (value range : 0x00 - 0x03 )

Bit8—Bit15	Lock level	Bit8—Bit15	Lock level	Bit8—Bit15	Lock level	Bit8—Bit15	Lock level
0x00	L.OFF	0x01	LOC.1	0x02	LOC.2	0x03	LOC.3

9-2、Bit8-Bit15: BAUD communication baud rate setting unit (value range:0x00-0x01)

Bit8-Bit15=0x00 : Baud rate =9600Bit/S (9600)

Bit8-Bit15=0x01 : Baud rate =4800Bit/S(4800)

9-3、Bit16-Bit23: ADD communication address setting unit of the meter (value range:0x01 - 0xf7)

9-4、Bit24-Bit31: CPS counting frequency high limit select unit (value range determined by the output mode).

Bit24—Bit31	Frequency high limit	Bit24—Bit31	Frequency high limit	Bit24—Bit31	Frequency high limit	Bit24—Bit31	Frequency high limit
0x00	1HZ	0x01	30HZ	0x02	1KHZ	0x03	5KHZ
0x04	10KHZ						

Remark: when output mode is mode D, the value range of Bit24 — Bit31 is ( 0x00 - 0x02), otherwise the value range is ( 0x00 - 0x04)

## 10.Data error code

10-1.Data error code: when it is checked no error of order format , meter address , function code and CRC checking , and when the master unit write error data to a register of the slave unit, the slave unit will feedback a corresponding error code .

The reflection are as follows :

Error code	Definition	Error code	Definition
0x14	OUT1 alarm value (PS1) error	0x15	OUT2 alarm value (PS2) error
0x16	BA.O alarm value (BA.S) error	0x17	SCL coefficient value error
0x18	W start value error	0x19	SIG input logic selection error
0x1A	OUT output mode selection error	0x1B	OUT1 output delay time selection error
0x1C	OUT2 output delay time selection error	0x1D	RST the min reset time selection error
0x1E	DP decimal point selection error	0x1F	DATA storage counting value selection error
0x20	IN counting input mode selection error	0x21	LOCK key lock function selection error
0x22	BAUD communication baud rate selection error	0x23	ADD communication address of the meter setting error
0x24	CPS the max counting speed selection error	0x25	
0x26		0x27	

Caution: When write data into the meter by communication interface, the written times of each register is limited . CI / CN series can be written at least 1000000 times . If written times more than the limit , it may cause damage to the register unit .