

Table of Contents

1	Introduction	5
2	Safety Measures	6
	2.1	Definition of signal warnings and symbols 6
	2.2	Product specific safety notes 6
3	Design and Function	9
	3.1	Overview 9
	3.2	Sensor connections 9
	3.3	T-Pad and hard keys 9
	3.4	Interface connection 11
	3.5	Display icons 11
	3.6	LED 13
	3.7	Acoustic signal 13
4	Putting into Operation	14
	4.1	Scope of delivery 14
	4.2	Installing the batteries 15
	4.3	Installing power supply 16
	4.4	Connecting sensors 17
	4.5	Installing optional equipment 18
	4.5.1	Electrode holder 18
	4.5.2	Meter base stabilizing unit 18
	4.5.3	Wrist strap 19
	4.6	Switching the instrument on and off 20
5	Instrument Setup	21
	5.1	Data storage 21
	5.1.1	Storage mode 21
	5.1.2	Storage destination 21
	5.2	System settings 22
	5.2.1	Language 22
	5.2.2	Time and date 22
	5.2.3	Access control 22
	5.2.4	Sounds and visuals 23
	5.2.5	User modes 23
	5.2.6	Power management 24
	5.3	Factory reset 24
	5.4	Instrument self-test 24
6	DO Settings	25
	6.1	Calibration settings 25
	6.1.1	Calibration reminder 25
	6.2	Measurement settings 26
	6.2.1	Salinity compensation 26
	6.2.2	Barometric compensation 26
	6.2.3	Barometric unit 26
	6.3	Endpoint type 27
	6.4	Interval readings 27
	6.5	Temperature settings 28
	6.6	Measurement limits 28

7	IDs		29	
		7.1	Sample ID	29
		7.2	User ID	29
		7.3	Sensor ID	30
8	Sensor Calibration		31	
		8.1	1-point calibration	31
		8.2	2-point calibration	31
9	Sample Measurement		32	
		9.1	Selecting a measurement unit	32
		9.2	Performing a DO measurement	32
10	Data Management		33	
		10.1	Data menu structure	33
		10.2	Measurement data	33
		10.3	Calibration data	34
		10.4	ISM data	34
		10.5	Data export to PC	35
11	Maintenance		36	
		11.1	InLab® OptiOx sensor maintenance	36
		11.2	Troubleshooting InLab® OptiOx	36
		11.3	Replacement of the OptiOx sensor cap	37
		11.4	Interfering substances of the InLab® OptiOx sensor	38
		11.5	Software update	38
		11.6	Repair of the instrument	38
		11.7	Disposal	38
12	Technical Data		39	
13	Product Portfolio		40	
		13.1	Meter and kit versions	40
		13.2	Accessories	40
14	Appendix		41	
		14.1	Dissolved Oxygen in relation to temperature	41

1 Introduction

Thank you for purchasing this high quality METTLER TOLEDO portable meter. Everywhere you measure pH, conductivity or dissolved oxygen - the Seven2Go™ portables are designed to offer you fast quality data, one-handed operation and an investment that lasts. Whether you work in the laboratory, at-line or outdoors, the Seven2Go™ meters will provide you with high quality measurement everywhere you go. The Seven2Go™ offers many exciting features, including:

- Simple and intuitive menus that shorten steps needed for setting up measurements and calibration
- T-pad hard keys for comfortable and fast navigation
- Rubber side-guards for comfortable, one-handed operation
- IP67 rating for the entire measurement system, including meter, sensor and the connection cables
- Useful accessories such as the electrode clip, the meter base stabilizing unit, the wrist strap and the uGo™ carrying case with hermetically sealed interior for easy cleaning

2 Safety Measures

2.1 Definition of signal warnings and symbols

Safety notes are marked with signal words and warning symbols. These show safety issues and warnings. Ignoring the safety notes may lead to personal injury, damage to the instrument, malfunctions and false results.

Signal words

WARNING	for a hazardous situation with medium risk, possibly resulting in severe injuries or death if not avoided.
CAUTION	for a hazardous situation with low risk, resulting in damage to the device or the property or in loss of data, or minor or medium injuries if not avoided.
Attention	(no symbol) for important information about the product.
Note	(no symbol) for useful information about the product.

Warning symbols



General hazard



Toxic substance



Inflammable or explosive substance

2.2 Product specific safety notes

Your instrument represents state-of-the-art technology and complies with all recognized safety rules, however, certain hazards may arise in extraneous circumstances. Do not open the housing of the instrument; it does not contain any parts that can be maintained, repaired or replaced by the user. If you ever have problems with your instrument, contact your authorized METTLER TOLEDO dealer or service representative.

Intended use



This instrument is designed for a wide range of applications in various areas and is suitable for measuring pH (S2, S8), conductivity (S3, S7) or dissolved oxygen (S4, S9).

The use therefore requires knowledge and experience in working with toxic and caustic substances as well as knowledge and experience working with application-specific reagents, which may be toxic or hazardous.

The manufacturer shall not be held liable for any damage resulting from incorrect usage divergent to the operating instructions. Furthermore, the manufacturer's technical specifications and limits must be adhered to at all times and in no way exceeded.

Location



The instrument has been developed for indoor and outdoor operation and may not be used in explosive environments.

Use the instrument in a location which is suitable for the operation, protected from direct sunlight and corrosive gases. Avoid powerful vibrations, excessive temperature fluctuations and temperatures below 0 °C and above 40 °C.

Protective Clothing

It is advisable to wear protective clothing in the laboratory when working with hazardous or toxic substances.



A lab coat should be worn.



Suitable eye protection such as goggles should be worn.



Use appropriate gloves when handling chemicals or hazardous substances, checking their integrity before use.

Safety notes



WARNING

Chemicals

All relevant safety measures are to be observed when working with chemicals.

- a) Set up the instrument in a well-ventilated location.
 - b) Any spills should be wiped off immediately.
 - c) When using chemicals and solvents, comply with the instructions of the producer and the general lab safety rules.
-



WARNING

Flammable solvents

All relevant safety measures must be observed when working with flammable solvents and chemicals.

- a) Keep all sources of flame away from the workplace.
 - b) When using chemicals and solvents, comply with the instructions of the producer and the general lab safety rules.
-

FCC Rules

This device complies with Part 15 of the FCC Rules and Radio Interference Requirements of the Canadian Department of Communications. Operation is subject to the following conditions: (1) this device may not cause harmful interference, and (2) this device must accept any interference received, including interference that may cause undesired operation.

This equipment has been tested and found to comply with the limits for a Class A digital device, pursuant to Part 15 of the FCC rules. These limits are designed to provide reasonable protection against harmful interference when the equipment is operated in a commercial environment. This equipment generates, uses, and can radiate radio frequency energy and, if not installed and used in accordance with the instruction manual, may cause harmful interference to radio communications. Operation of this equipment in a residential area is likely to cause harmful interference in which case the user will be required to correct the interference at his own expense.

3 Design and Function

3.1 Overview

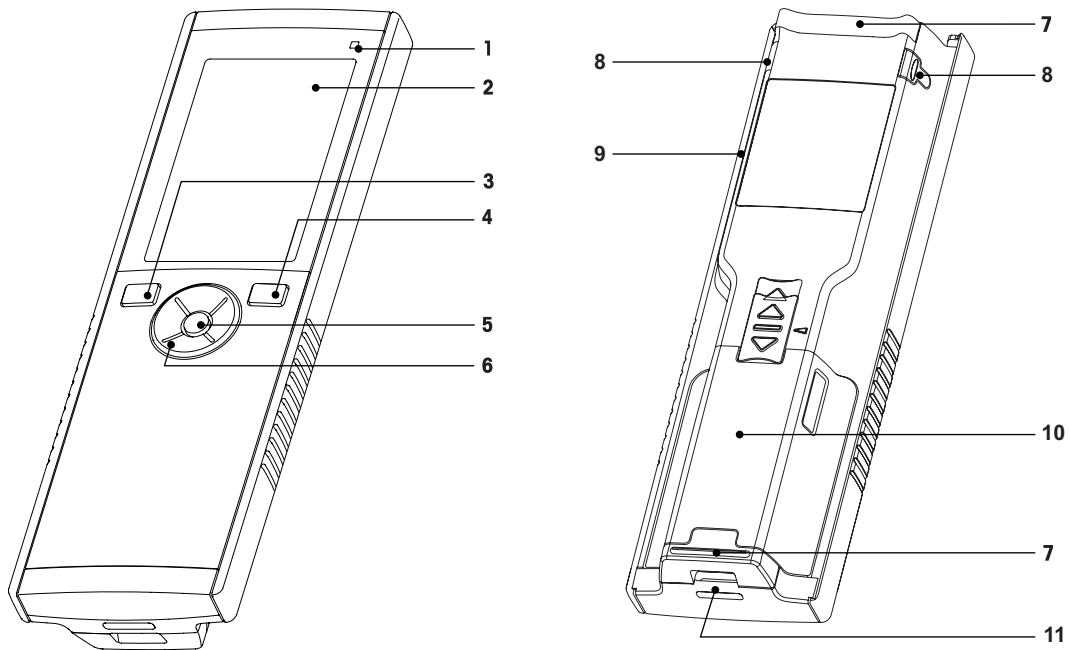

- 1** Status LED (only Pro-series)
- 2** Display
- 3** Calibration key
- 4** On/Off key
- 5** Read key
- 6** T-Pad

- 7** Rubber feet
- 8** Fixing points for electrode holder
- 9** Micro-USB port (only Pro-series)
- 10** Battery compartment
- 11** Slot for wrist strap

3.2 Sensor connections

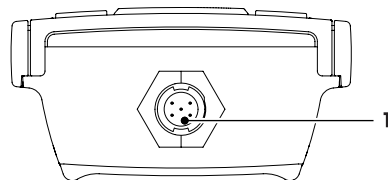



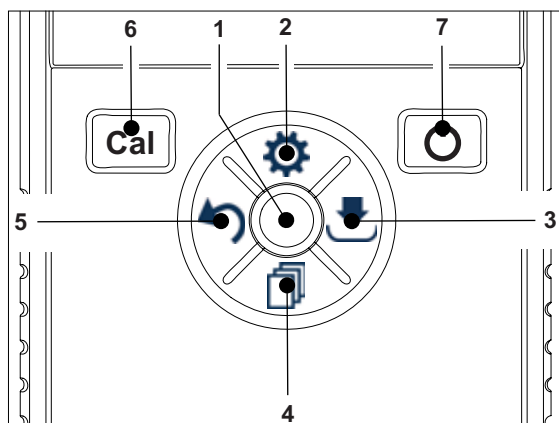

- 1** Mini-LTW socket for digital electrode





3.3 T-Pad and hard keys







In Standard Screen

	Key	Press and Release	Press and hold
1	Read	Start and manually stop a measurement	Activate/Deactivate uFocus™
2	Settings/Up 	Open setup menu	---
3	Store/Right 	Save last measurement data	---
4	Mode/Down 	Switch measurement mode	---
5	Recall/Left 	Recall measurement data	---
6	Cal	Start calibration	Recall last calibration result
7	On/Off 	---	Switch instrument on (hold for 1 second) or off (hold for 3 seconds)

In calibration mode (indicated by)

	Key	Press and Release	Press and hold
1	Read	Manually stop calibration Save calibration result Exit calibration mode	Activate/Deactivate uFocus™
2	Settings/Up 	---	---
3	Store / Right 	---	---
4	Mode/Down 	---	---
5	Recall/Left 	---	Discard calibration result
6	Cal	---	---
7	On/Off 	---	---

Settings and data menu

	Key	Press and release	Press and hold
1	Read	Select submenu Confirm setting	Exit menu
2	Settings / Up 	Edit value (increase) Navigate between menu points	Fast value increase
3	Store / Right 	Navigate between menu tabs (only in top level per tab)	---
4	Mode / Down 	Edit value (decrease) Navigate between menu points	Fast value decrease
5	Recall / Left 	Navigate between menu tabs (only in top level per tab) One level up (if not in top level) Move left (in input fields)	One level up (if entering value into input field)
6	Cal	---	---
7	On / Off 	---	---

3.4 Interface connection

The Micro-USB interface can be used for data transfer to a connected PC (LabX direct software) and for external power supply. It is not possible to charge the batteries.

- 1 Micro-USB port

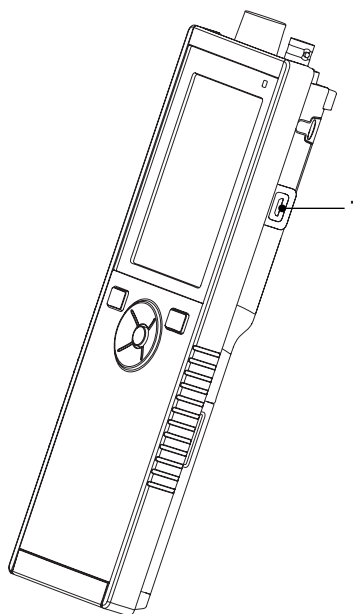







See also

- Installing power supply (page 16)

3.5 Display icons

Icon	Description
	Power status <ul style="list-style-type: none"> ▣ 100% (fully charged) ▣ 75% ▣ 50% ▣ 25% ▣ 0% (fully discharged) ⚡ External power supply connected (USB)
	USB-PC connection: LabX@direct
	User mode <ul style="list-style-type: none"> Ⓜ Routine Ⓜ Expert Ⓜ Outdoor
	Storage mode <ul style="list-style-type: none"> Ⓜ Automatic Ⓜ Manual
	Interval Reading is on
	GLP format is used
	ISM sensor has been detected and is properly connected
	Warning / Error occurred

Icon	Description
	Sample ID
	User ID
	Sensor ID
	Endpoint type \overline{A} Automatic \overline{T} Timed \overline{M} Manual
	Wait icon
	Sensor cap life status: <ul style="list-style-type: none"> ● Cap life > 6 months ◐ Cap life > 3 months ◑ Cap life > 1 months ◒ Cap life > 2 weeks ◓ Cap life > 2 days ○ Cap life < 2 days

3.6 LED

To use the LED, it has to be enabled in the instrument setup, see section Sounds and visuals (page 23). The LED indicates different information of the device:

- Alarm Messages
- Measurement endpoint
- System Info

Instrument State	LED green	LED red	LED orange	Meaning
Instrument turn ON	On for 5 s			<ul style="list-style-type: none"> • Instrument boot up
		Blinking		<ul style="list-style-type: none"> • Instrument has failed to boot correctly or failure after booting • Error message appears
Instrument running without calibration or measurement in progress		Blinking		<ul style="list-style-type: none"> • Calibration has expired and user has defined instrument to be blocked if sensor expires - error message displayed • Any other error occurred and is displayed
Measurement Mode	Pulsing			<ul style="list-style-type: none"> • Measurement in progress
	Solid			<ul style="list-style-type: none"> • Measurement complete
		Blinking		<ul style="list-style-type: none"> • Measurement outside limits • Error occurred
Calibration Mode	Pulsing			<ul style="list-style-type: none"> • Calibration in progress
	Solid			<ul style="list-style-type: none"> • Calibration complete
		Blinking		<ul style="list-style-type: none"> • Calibration not successful • Error occurred
Data Transfer	Pulsing			<ul style="list-style-type: none"> • Data transfer in progress
	Solid			<ul style="list-style-type: none"> • Data transfer complete
		Blinking		<ul style="list-style-type: none"> • Data transfer not successful • Error occurred
Sleep Mode			Solid	<ul style="list-style-type: none"> • Meter in Sleep Mode • Press On/Off to re-activate meter

3.7 Acoustic signal

To use the acoustic signals, they have to be enabled in the instrument setup (see section Sounds and visuals (page 23)). You can enable or disable the acoustic signal for the following features:

- Keypress
- Alarm Messages
- Measurement endpoint

4 Putting into Operation

4.1 Scope of delivery

Check the completeness of the delivery. The following parts belong to the standard equipment of your new instrument. Further parts may be included depending on the ordered kit versions.

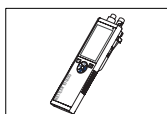

S9 instrument
for DO measurement

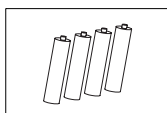

Battery LR3/AA 1.5V
4 pcs.

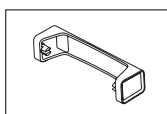

Meter base unit



CD-ROM including operating instructions

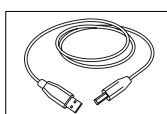

USB-A to micro-USB cable for connection to PC,
length = 1 m

See also

- Product Portfolio (page 40)

4.2 Installing the batteries

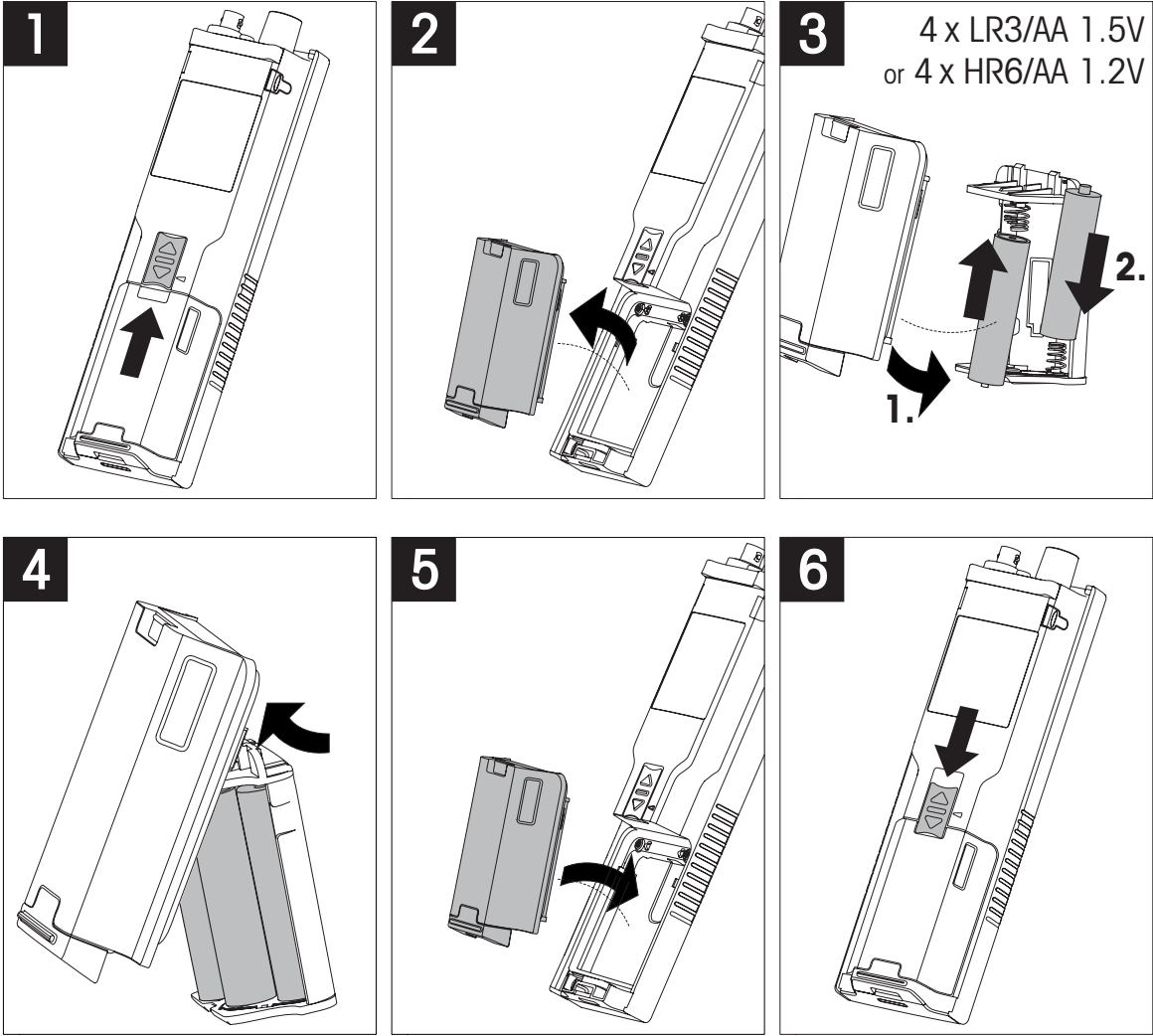

4.3 Installing power supply

The instrument is not supplied with an AC adapter.

Alternatively, the instrument can be supplied by an external power supply unit (not included in the scope of delivery) via the Micro-USB socket. Use an AC adapter that is suitable for all line voltages in the range of 100 to 240 V, 50/60 Hz and incorporates a USB socket. For connection, a suitable USB cable with an Micro-USB plug is required.

While the instrument is powered by the external power supply, the batteries are not being used. The icon  is shown on the screen.

Attention

- Take care that the AC adapter does not come into contact with liquids!
- The power plug must be accessible at all times!

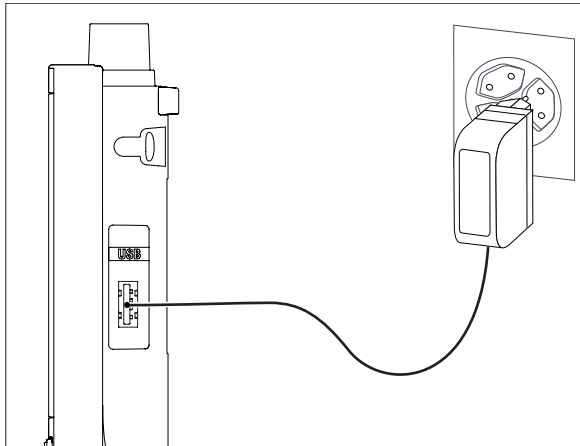

- 1 Connect the cable of the AC adapter with the Micro-USB socket of the instrument.
- 2 Plug the AC adapter into the wall socket.

4.4 Connecting sensors

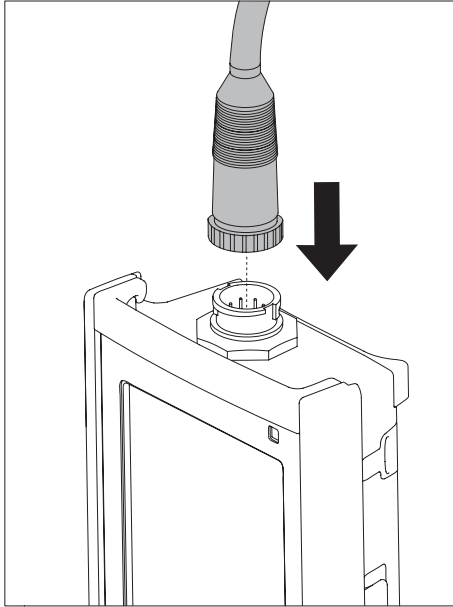

ISM® sensor

When connecting an ISM® sensor to the meter, one of the following conditions have to be met for the calibration data to be transferred automatically from the chip of the sensor into the meter and is used for further measurements. After attaching the ISM® sensor ...

- The meter must be switched on.
- (If the meter is already switched on) the **READ** key is pressed.
- (If the meter is already switched on) the **CAL** key is pressed.

We strongly recommend you to switch off the meter when disconnecting an ISM sensor. In doing so, you make sure that the sensor is not removed while the instrument is reading data from or writing data to the ISM-chip of the sensor.

The **ISM** icon  appears on the display and the sensor ID of the sensor chip is registered and appears on the display.

The calibration history, the initial certificate and the maximum temperature can be reviewed and printed in the data memory.

4.5 Installing optional equipment

4.5.1 Electrode holder

For a safe placing of the electrode you can mount an electrode holder on the side of the instrument. The electrode holder is part of delivery. You can mount it on either sides of the instrument for your personal handling.

- 1 Remove the protective clips (1).

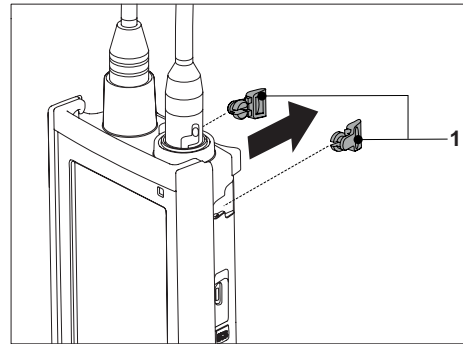

- 2 Push the electrode holder (1) into the recess (2) of the instrument.

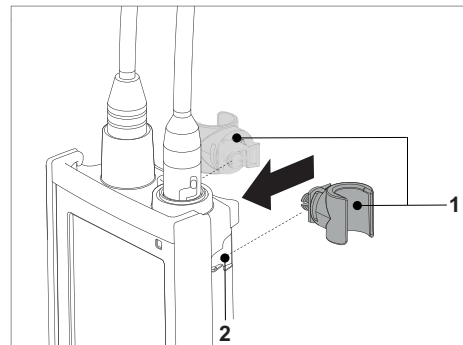

4.5.2 Meter base stabilizing unit

The meter base stabilizing unit should be mounted when using the instrument on a desk. It ensures a more firm and secure stand when pressing the keys.

- 1 Remove the protective clips (1).

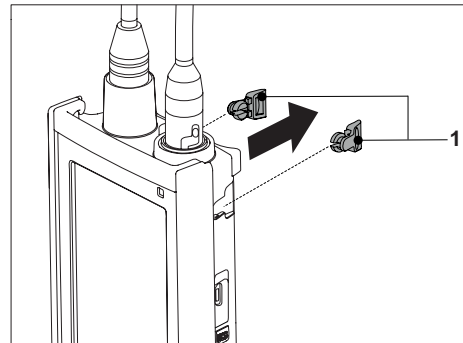

- 2 Push the meter base stabilizing unit (1) into the recesses (2) of the instrument.

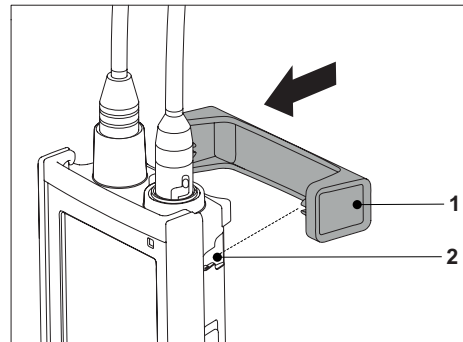

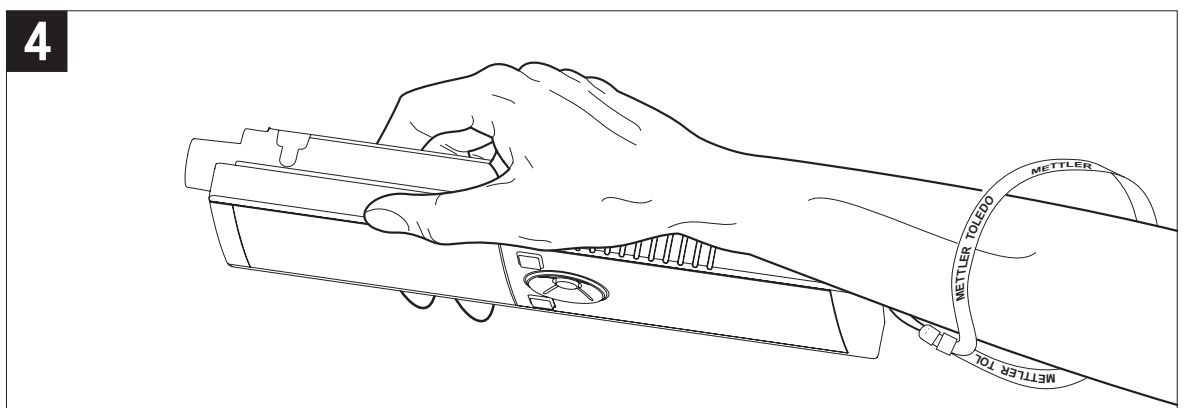
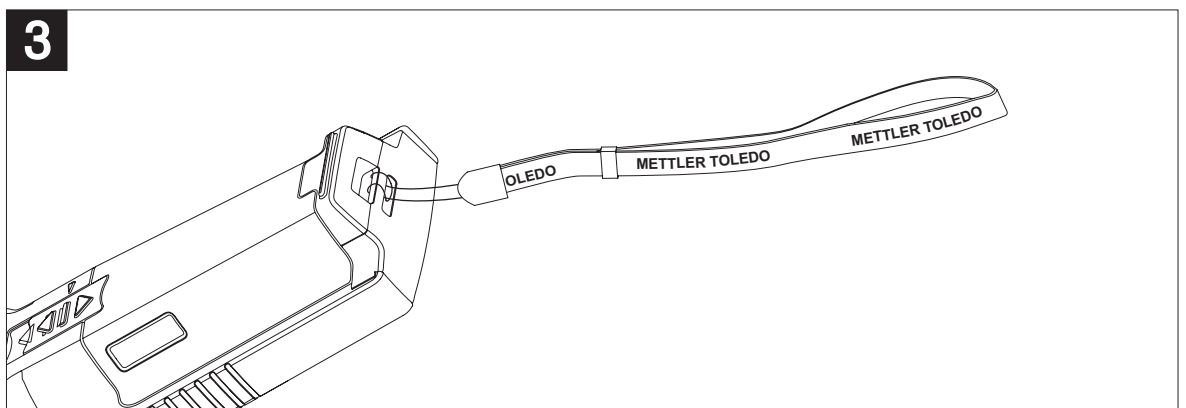
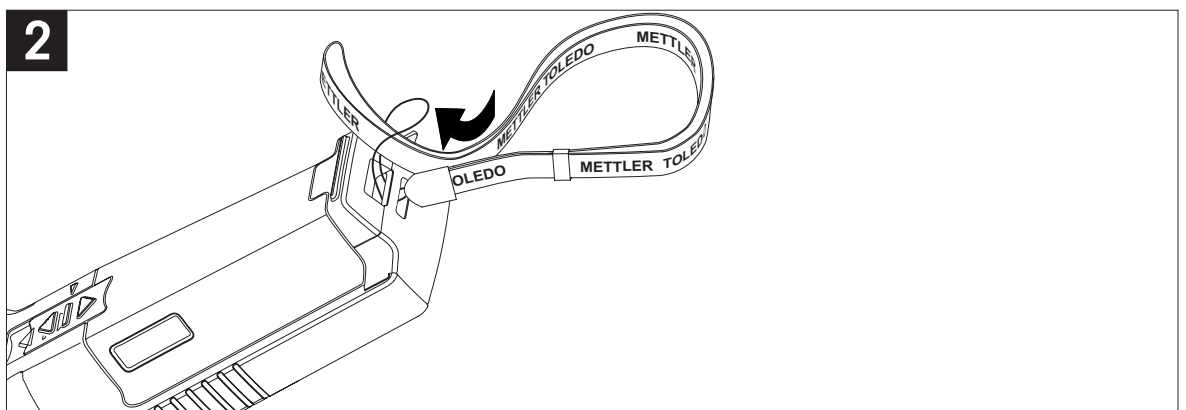
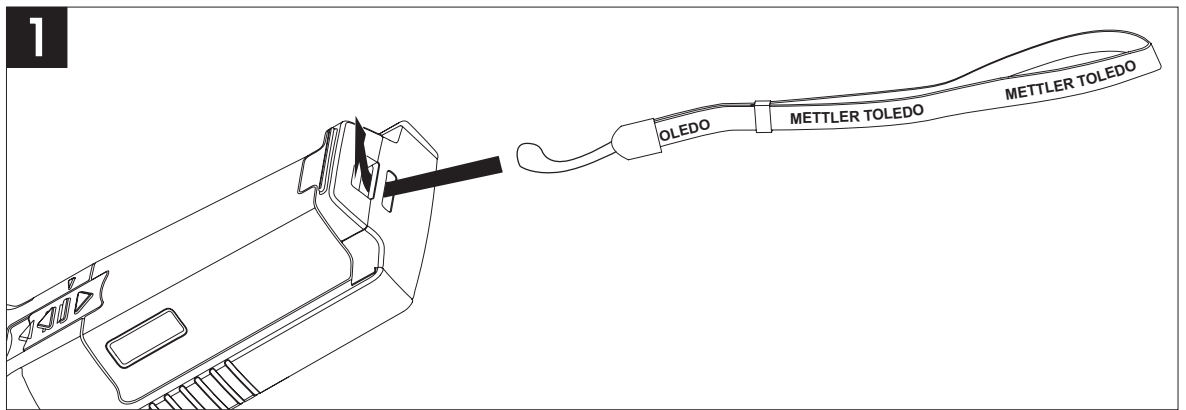

4.5.3 Wrist strap

For better protection against damage caused by dropping, you can mount the wrist strap as shown in the following diagrams.



4.6 Switching the instrument on and off

- 1 Press  to switch on the instrument.
 - ⇒ The firmware version, the serial number and the current date are displayed for about 5 seconds. After that the instrument is ready for use.
- 2 Press  for 3 seconds and release to switch off the instrument.

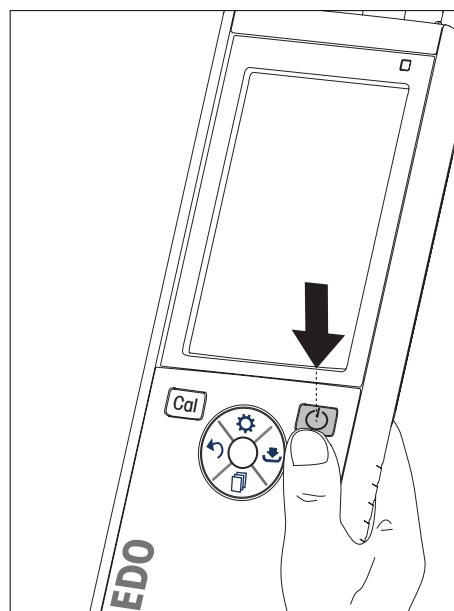



Note

- By default after 10 minutes not in use, the instrument changes to sleep mode. This can be changed in the setup.
- When starting the meter for the first time, the display for entering time and date appears automatically. These settings can be changed later again.

See also

- Power management (page 24)
- Time and date (page 22)

5 Instrument Setup

- 1 Press  to enter the menu.
- 2 Go to .

Menu structure

1.	Data Storage
1.1	Storage Mode
1.1.1	Automatic Storage
1.1.2	Manual Storage
1.2	Storage Destination
1.2.1	Memory
1.2.2	LabX Direct
1.2.3	Memory + LabX Direct
2.	System Settings
2.1	Language
2.2	Time and Date
2.3	Access Control
2.4	Sounds & Visuals
2.5	User Mode
2.6	Power Management
3.	Factory Reset
4.	Instrument Self-test

5.1 Data storage

5.1.1 Storage mode

- **Automatic storage:**
In this storage mode, all measurement results are getting saved automatically to the selected storage destination.
- **Manual storage:**
In this mode, the user has to save a measurement result manually by pressing . For this, the user gets a message on the display after every measurement.

5.1.2 Storage destination

There are different possibilities to store the measurement results. The Seven2Go pro meter provides 2000 internal memory locations (**M0001 - M2000**).

- **Memory:**
The measurement results are saved in the internal memory.
- **LabX Direct:**
The measurement results are transferred only to LabX Direct. For this a PC connection via USB is required. The PC software LabX®direct must be setup accordingly.
- **Memory + LabX Direct:**
The measurement results are saved in the internal memory and transferred to LabX®Direct. For this a PC connection via USB is required. The PC software LabX®direct must be setup accordingly.

5.2 System settings

5.2.1 Language

The following languages are available for the system:

- English
- German
- French
- Spanish
- Italian
- Portuguese
- Polish
- Russian
- Chinese
- Japanese
- Korean
- Thai

5.2.2 Time and date

When starting the meter for the first time, the display for entering time and date appears automatically. In the system settings, two time and four date display formats are available:

- **Time**
 - 24-hour format (for example, 06:56 and 18:56)
 - 12-hour format (for example, 06:56 AM and 06:56 PM)
- **Date**
 - 28-11-2013 (day-month-year)
 - 11-28-2013 (month-day-year)
 - 28-Nov-2013 (day-month-year)
 - 28/11/2013 (day-month-year)

5.2.3 Access control

PIN settings are available for:

- **System Settings**
- **Deletion of Data**
- **Instrument Login**

A maximum of 6 characters can be entered as PIN. When enabling an access control, the PIN must be defined and re-entered for verification.

Note

- Access control for system settings cannot be disabled as long as the instrument is operated in routine mode!

See also

- User modes (page 23)

5.2.4 Sounds and visuals

An acoustic signal can be switched on or off for the following three cases:

- Key is pressed
- Alarm/warning message appears
- Measurement is stable and has endpointed (stability signal appears)

The LED can be switched on or off for the following three cases:

- Alarm message
- Measurement endpoint
- System info

5.2.5 User modes

The meter has three user modes:

Routine Mode:

Limited access rights. The user can only perform measurements, calibrations, review results and change basic settings. The concept of the routine mode is a GLP feature which ensures that important settings and stored data cannot be deleted or unintentionally changed. The following operations are blocked in routine mode:

- Deletion of data
- Measurement and Calibration settings (except choosing reference temperature)
- Create sensor ID
- Factory reset
- Instrument self-test
- System settings can be accessed by entering PIN code (by default 000000)

Expert Mode:

The factory default setting enables all functions of the meter.

Outdoor Mode:

The user has full access rights (like in expert mode). The screen is always in uFocus view and the following parameters are set to specific values to reduce battery consumption:

- Auto dimming after 20 s
- Auto shutdown after 10 min
- All LED signals off

5.2.6 Power management

Screen Brightness:

The screen brightness can be set from levels 1 to 16.

Auto Dimming:

You can activate the auto dimming function for power saving. For this you can define a time period from 5 - 300 s. This is the time when the period backlight is switched off after the instrument is not in use.

Energy Saving:

You can activate either auto sleep or auto shutdown for saving energy.

Auto Sleep

The instrument changes into the sleep modus (standby) after a defined time of not in use. The instrument does not shut down automatically. You can define a time period between 5 - 99 minutes. The orange LED light indicates that the instrument currently is in sleep mode. Press  to activate the meter.

Auto Shutdown

The instrument shuts down automatically after a defined time of not in use. You can define a time period between 5 - 99 minutes.





5.3 Factory reset



Note



Loss of data!

With a factory reset all settings will be set to default values and all data memories will be deleted.

- 1 Press  to enter the setup menu.
- 2 Go to  > **Factory Reset**.
- 3 Press **Read** to confirm the factory reset or press  to cancel.
 - ⇒ When confirmed, all settings have default values and the memory is fully cleared.
- 4 Press and hold  to exit the setup menu.

5.4 Instrument self-test

The instrument self-test allows to check if display, LED, beep and keys are working correctly.

- 1 Press  to enter the setup menu.
 - 2 Go to  > **Instrument Self-test**.
 - 3 Press **Read** to start the self-test.
 - ⇒ **Display:** All pixels of the display are shown black for 2 seconds, then white for 2 seconds.
 - ⇒ **LED:** The LED changes color to green, orange and flashing red.
 - ⇒ **Beep and keys:** The icons for the seven keys are shown on the screen, each keypress lets its icon disappear while a beep sounds. The keys must be pressed within 20 seconds.
- ⇒ If the self-test is successful, **OK** appears on the screen and the LED is green for 2 seconds. Otherwise **Self-test failure** appears and the LED flashes red. In both cases the instrument then goes back to normal mode.

6 DO Settings





- 1 Press  to enter the menu.
- 2 Go to **DO Settings**.

1.	Calibration Settings
1.1	Calibration Reminder
2.	Measurement Settings
2.1	Salinity Compensation
2.2	Baro. Compensation
2.3	Barometric Unit
3.	Endpoint Type
4.	Interval Readings
5.	Temperature Settings
5.1	Temperature Unit
6.	Measurement Limits
6.1	DO Limit
6.2	Temperature Limit

6.1 Calibration settings

6.1.1 Calibration reminder





When the calibration reminder is activated, the user is reminded to perform a new calibration after a certain user-defined interval (maximum 9999 h) has elapsed.

- 1 Press  to enter the setup menu.
- 2 Go to **DO > Calibration Settings > Calibration Standard > Calibration Reminder** .
- 3 Choose **On** or **Off** by using  and .
- 4 Press **Read** to confirm.
 - ⇒ Another screen appears to enter the interval time.
- 5 Enter the interval time by using the TPad keys and press **Read** to save.
 - ⇒ Another screen appears to select calibration expiration date. Select as of when the sensor should be blocked for further measurements as soon as the entered interval has elapsed.
 - ⇒ **Immediately:**
The meter is immediately blocked for measurement when the predefined interval has elapsed.
 - ⇒ **Exp: Reminder + 1 h:**
The meter is blocked for measurement 1 hour after the predefined interval has elapsed.
 - ⇒ **Exp: Reminder + 2 h:**
The meter is blocked for measurement 2 hours after the predefined interval has elapsed.
 - ⇒ **Continue Reading:**
The user can continue measuring when the predefined interval has elapsed.
- 6 Press **Read** to confirm.
- 7 Press .
- 8 Press and hold  to exit the setup menu.

6.2 Measurement settings





6.2.1 Salinity compensation

The oxygen concentration depends on temperature and salinity of the sample. It is recommended to determine the salinity of a sample prior to the oxygen concentration. The salinity can be entered in the settings.

- 1 Press  to enter the setup menu.
- 2 Go to **Measurement Settings > Salinity Compensation**.
- 3 Enter the salinity (0.0 - 42.0 psu) digit by digit by using  and  and press **Read**.
- 4 Press .
- 5 Press and hold  to exit the setup menu.

6.2.2 Barometric compensation



The instrument is equipped with a pressure sensor that measures the barometric pressure during the oxygen measurement and compensates the reading accordingly. Alternatively, the barometric pressure can be entered manually to be used for the compensation.

- 1 Press  to enter the setup menu.
- 2 Go to **Measurement Settings > Baro. Compensation**.
- 3 Choose between **Automatic** and **Manual** by using  and  and press **Read**.
- 4 Press .
- 5 Press and hold  to exit the setup menu.

6.2.3 Barometric unit

You can set the pressure unit to:



- mbar
- hPa
- mmHg (torr)
- atm

- 1 Press  to enter the setup menu.
- 2 Go to **Measurement Settings > Barometric Unit**.
- 3 Select the pressure unit and press **Read** to confirm.
- 4 Press .
- 5 Press and hold  to exit the setup menu.

6.3 Endpoint type



Auto Endpoint

With the automatic endpoint the meter defines the end of an individual reading depending on programmed stability criterion for the signal. This ensures an easy, quick and precise measurement.

- 1 Press  to enter the setup menu.
- 2 Go to **DO > Endpoint Type**.
- 3 Select **Auto EP** and press **Read** to confirm.
- 4 Press and hold  to exit the setup menu.



Manual Endpoint

In this mode, the user is required to stop the measurement reading manually.

- 1 Press  to enter the setup menu.
- 2 Go to **DO > Endpoint Type**.
- 3 Select **Manual EP** and press **Read** to confirm.
- 4 Press and hold  to exit the setup menu.

Timed Endpoint

The measurement stops after the defined time, which can be set between 5 s and 3600 s.



- 1 Press  to enter the setup menu.
- 2 Go to **DO > Endpoint Type**.
- 3 Select **Timed EP** and press **Read** to confirm.
- 4 Enter the measurement time digit by digit using the TPad keys and press **Read** to save.
- 5 Press and hold  to exit the setup menu.

6.4 Interval readings

A reading is taken every time after a certain interval (1 – 2400 s) defined in the menu has elapsed. The measurement series stops according to the selected endpoint format or manually by pressing **Read**. When timed-interval reading is **On**, ^{Int.} appears on the screen.

Example:



To measure the conductivity every 30 s during 5 min, set the interval time to 30 s and the endpoint type to timed with a measurement time of 5 min.

- 1 Press  to enter the setup menu.
- 2 Go to **DO > Interval Readings**.
- 3 Select **On** and press **Read** to confirm.
- 4 If interval readings has been enabled, enter the interval time digit by digit using the TPad keys.
- 5 Press **Read** save.
- 6 Press and hold  to exit the setup menu.

6.5 Temperature settings

Setting the temperature unit:

You can set the temperature unit to °C or °F.













- 1 Press  to enter the setup menu.
- 2 Go to **DO > Temperature Settings > Temperature Unit**.
- 3 Select the temperature unit and press **Read** to save.
- 4 Press .
- 5 Press and hold  to exit the setup menu.

6.6 Measurement limits

You can define limits (max. and min.) for every kind of measurement:

- **DO Limit**
- **Temperature Limit**

To set a measurement limit follow these steps:

- 1 Press  to enter the setup menu.
- 2 Go to **DO > Measurement Limits**.
- 3 Choose the desired measurement type by using  and  and press **Read** to confirm.
- 4 Select **Yes** to activate the limit and press **Read** to confirm.
- 5 Press **Read** to activate or deactivate the max. Limit.
- 6 Press  and then press **Read** to edit the max. limit value.
- 7 Change the max. limit value digit by digit using  and  and press **Read** to save.
- 8 Press  to switch to the min. limit.
- 9 Press **Read** to activate or deactivate the min. Limit.
- 10 Press  and then press **Read** to edit the min. limit value.
- 11 Change the min. limit value digit by digit using  and  and press **Read** to save.
- 12 Go to **Save** and press **Read** to save your settings.
- 13 Press .
- 14 Press and hold  to exit the setup menu.

7 IDs

- 1 Press  to enter the menu.
- 2 Go to **ID**.

Menu structure

1.	Sample ID
1.1	Enter Sample ID
1.2	Auto Sequential
1.3	Select Sample ID
1.4	Delete Sample ID
2.	User ID
2.1	Enter User ID
2.2	Select User ID
2.3	Delete User ID
3.	Sensor ID
3.1	Enter Sensor ID

7.1 Sample ID

- 1 Press  to enter the setup menu.
- 2 Go to **ID Settings > Sample ID**.

Go to **Enter Sample ID** to enter a new sample ID. An alphanumeric sample ID with up to 12 characters can be entered.

Auto sequential:

1. **Auto Sequential = On**

Using this setting will automatically increment the sample ID by 1 for each reading. If the last character of the sample ID is not a number, then the number 1 will be added to the sample ID with the second sample. This requires the sample ID to have less than 12 characters.

2. **Auto Sequential = Off**

The sample ID is not incremented automatically.

To select a sample ID out of a list of already entered sample IDs, go to **Select Sample ID**. A maximum of 10 sample IDs are stored in memory and listed for selection. If the maximum of 10 has already been entered, either any sample ID is deleted manually or the oldest ID will automatically be overwritten by the new ID.

To delete an existing sample ID out of the list, go to **Delete Sample ID**. Choose the sample ID you want to delete and press **Read**.

7.2 User ID

- 1 Press  to enter the setup menu.
- 2 Go to **ID Settings > User ID**.

Select **Enter User ID** to enter a new user ID. An alphanumeric user ID with up to 12 characters can be entered.

To select a user ID out of the list, go to **Select User ID**. A maximum of 10 user IDs are stored in memory and listed for selection. If the maximum of 10 has already been entered, either a user ID is deleted manually or the oldest ID will automatically be overwritten by the new ID.

To delete an existing user ID out of the list, go to **Delete User ID**. Choose the user ID you want to delete and press **Read**.

7.3 Sensor ID

The name of the connected DO sensor can be modified.

- 1 Press  to enter the setup menu.
- 2 Go to **ID Settings > Sensor ID**.
- 3 Select **Enter Sensor ID** to enter a new sensor ID. An alphanumeric sensor ID up to 12 characters can be entered.

8 Sensor Calibration





Note

Sensor cap lifetime

The cap of the DO sensor has a limited lifetime of one year. The residual cap life is indicated on the measurement screen with an icon (see section Display icons (page 11)) and can be reviewed in the instrument's data section (see section ISM data). With an expired cap no measurements are possible. For further information about replacing the sensor cap, see section Replacement of the OptiOx sensor cap (page 37).

- The membrane must be examined for damage or contamination. If the membrane is dirty, clean carefully with a soft, moist cloth.
- For standard oxygen measurements a 1-point calibration at 100% is sufficient. The instrument set the calibration point for 0% automatically. For low oxygen concentration measurements (below 10% or 0.8 mg/L) it is recommended to perform a 2-point calibration with a second point in a zero oxygen solution.

8.1 1-point calibration

- 1 For calibration in vapor-saturated air (equals 100% oxygen saturation of water) place the sensor in its calibration tube whereof the sponge on the other end of the white tube is wet. Leave the sensor there for at least 5 min to allow equilibration.
- 2 Press **Cal** to enter the calibration mode.
 - ⇒ The calibration icon  appears on the display.
- 3 Press **Read** to start the calibration.
 - ⇒ Depending on the set endpoint format, the letter **A** (auto), **T** (timed) or **M** (manual) is blinking during the calibration.
 - ⇒ When the endpoint is reached, the display freezes automatically. Independent on the set endpoint format, **Read** can be pressed to endpoint the calibration manually.
- 4 To end the 1-point calibration, press .
- ⇒ The calibration result is displayed.
- 5 Press **Read** to save the calibration data or press  to cancel.

8.2 2-point calibration

- 1 Follow steps 1 to 3 for a 1-point calibration (see section 1-point calibration (page 31)).
- 2 Immerse the sensor in a zero oxygen solution and press **Read** to start the calibration.
 - ⇒ Depending on the set endpoint format, the letter **A** (auto), **T** (timed) or **M** (manual) is blinking during the calibration.
 - ⇒ When the endpoint is reached, the display freezes automatically. Independent on the set endpoint format, **Read** can be pressed to endpoint the calibration manually.
 - ⇒ The calibration result is displayed.
- 3 Press **Read** to save the calibration data or press  to cancel.

9 Sample Measurement



9.1 Selecting a measurement unit

With the S9 DO meter it is possible to measure the following parameters of a sample:

- %
- mg/L
- ppm

To change the measurement mode, press  as often as the desired appears.

9.2 Performing a DO measurement

- ▶ A sensor is connected to the instrument.
 - ▶ The sensor is calibrated.
 - ▶ The following measurement settings are done:
 - Salinity compensation
 - Barometric pressure compensation
 - Endpoint type
 - Data storage mode and location
- 1 Press  once or several times to switch between the measurement modes until the relevant unit (mg/L, ppm, %) is displayed.
 - 2 Place the sensor into the sample and press **Read** to start the measurement.
 - ⇒ The decimal point and - depending on the endpoint format setting - **A** (automatic), **T** (timed) or **M** (manual) are blinking during the measurement.
 - 3 When the measurement has endpointed, the display freezes. Independent on the set endpoint format, **Read** can be pressed to endpoint the measurement manually.
 - ⇒ The measurement result is displayed.
 - ⇒ If Data Storage Mode is set to **Automatic Storage**, the complete measurement data is automatically transferred to the set storage destination.
 - 4 If Data Storage Mode is set to **Manual Storage**, press  to transfer the data to the set storage location.

Information on the display:

The following symbols appear on the display, depending on the endpoint setting.

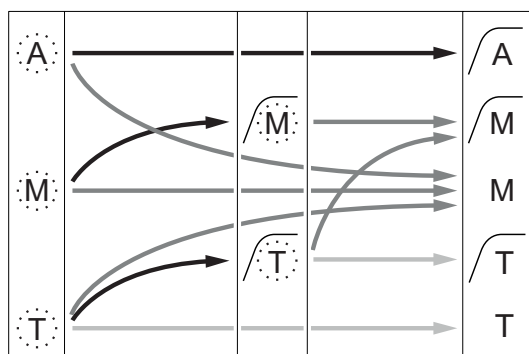

- Defined measurement time elapsed
- User presses **Read**
- Signal becomes stable

- Measurement stopped automatically, reading was stable
- Measurement stopped manually, reading was stable
- Measurement stopped manually, reading was not stable
- Measurement stopped after time, reading was stable
- Measurement stopped after time, reading was not stable

10 Data Management

10.1 Data menu structure

Press  to enter and also to exit the setup menu.

1.	Measurement Data
1.1	Review
1.2	Transfer
1.3	Delete
2.	Calibration Data
2.1	Review
2.2	Transfer
2.3	Delete
3.	ISM Data
3.1	Initial Calibration Data
3.2	Calibration History
3.3	Electrode Records
3.4	Sensor cap life
3.5	Reset ISM

10.2 Measurement data

Review > All

Transfer > All

Delete > All:

All stored measurement data can be reviewed, transferred or deleted. The most recent data saved appears on the display.

Review > Partial

Transfer > Partial

Delete > Partial:

Partially selected measurement data can be reviewed, transferred or deleted. The measurement data can be filtered according to 4 criteria.

- Date/Time
- Sample ID
- Measurement mode
- Memory number

Note

- When filtering by date/time, the date must always be entered. If the time 00:00 is used, all results from the whole day are showed/transferred/deleted. Otherwise only the results exactly at the given date and time are affected.

Delete > All After Transfer:

All stored measurement data can be transferred to a PC with software LabX@direct. The measurement data will be deleted automatically after transfer.

10.3 Calibration data

Review:

The stored calibration data of the selected sensor can be reviewed.

Transfer:

All stored calibration data of the selected sensor can be transferred to a PC with software LabX@direct.

Delete:

The calibration data of the selected sensor is deleted.

Note

- It is not possible to delete the active sensor. Choose a different one from the sensor ID list first.

10.4 ISM data

Seven2Go meters incorporate Intelligent Sensor Management (ISM[®]) technology. This ingenious functionality provides extra security, safety and eliminates mistakes. The most important features are:

Extra security!

- After connecting the ISM[®] sensor, the sensor is automatically recognized and the sensor ID and serial number are transferred from the sensor chip to the meter. The data is also printed on the GLP printout.
- After calibration of the ISM[®] sensor, the calibration data is automatically stored from the meter to the sensor chip. The most recent data is always stored where it should be – on the sensor chip!

Extra safety!



After connecting the ISM[®] sensor, the five most recent calibrations are transferred to the meter. These can be reviewed to see the development of the sensor over time. This information provides an indication if the sensor should be cleaned or renewed.

Eliminate mistakes!

After connecting an ISM[®] sensor, the last set of calibration data is automatically used for measurements.

Additional features are described below.

Calibration History

The last 5 calibrations data stored in ISM[®] sensor including current calibration can be reviewed or transferred. Use  and  to move between the calibration data. Press and hold  to leave the calibration history view.

Electrode Records

The sensor name, serial number and the maximum temperature ever measured with this sensor (incl. date when this happened) is displayed.

Sensor cap life

The date of first usage of the installed sensor cap and the expiry date as well as its serial number is displayed.

Reset ISM[®]





The calibration history in this menu can be deleted. This menu is protected by a deletion PIN. Upon delivery, the PIN for deletion is set to 000000. Change the PIN to prevent unauthorized access.

10.5 Data export to PC

It is possible to transfer either all data or a user-defined set of data from the memory to a PC by using LabX@direct. The settings between the instrument and PC are adjusted automatically because USB connection is plug-and-play.

The following section describes how to proceed with the different configurations.

Data transfer from the meter to LabX@direct

- 1 Connect the instrument via USB-B to the PC.
⇒  appears on the display.
- 2 Press  to enter the setup menu.
- 3 Go to  > **Data Storage** > **Storage Destination** and select **LabX Direct**.
- 4 Press  for 3 s to leave the setup menu.
- 5 Open the software **LabX@direct pH** and select the correct instrument.
- 6 Press  to enter the data menu.
- 7 Go to **Measurement Data** > **Transfer** and select the data you want to transfer.
⇒ The transfer starts automatically after the data content is selected.

11 Maintenance

11.1 InLab® OptiOx sensor maintenance

Storage

- 1 Do not remove the sensor cap.
- 2 The sensor can be stored dry. It is recommended to keep it in the white calibration tube to protect the sensor cap from mechanical damage.
- 3 Keep the sensor away from direct sunlight during storage.

Cleaning the sensor cap and body

- 1 Do not remove the sensor cap.
- 2 Rinse the sensor with distilled water.
- 3 Gently wipe with a soft-bristled brush or soft cloth if biofouling is present.
- 4 If extensive mineral build-up is present, soak the cap end in vinegar for 15 minutes.
- 5 Soak the sensor in deionized water for 15 minutes and blot it dry with a lint-free tissue.
- 6 After cleaning the sensor, 1-point calibration should be performed to check it.

Note

- Do not use organic solvents or soaps to clean the cap!
- Cleaning of the inner lens should only be performed when changing the cap.

11.2 Troubleshooting InLab® OptiOx

Issue	Recommended Action
Unable to calibrate	Verify the calibration setup and procedure. Make sure that no water droplets are on the surface of the cap. Verify that the cap lifetime has not expired yet.
Measurements are unstable	Measurements may take longer if the solution temperature is unstable.
Measurement is too low	Salt may be present in the sample. Set the salinity factor in the meter.
Wrong temperature displayed	Verify that the temperature sensor (metallic pin along the sensor shaft) is immersed in the solution.

- 1 Rinse the sensor thoroughly with distilled water, blot it dry with a lint-free tissue and examine the cap for scratches or discoloration.
- 2 Remove the cap from the sensor and make sure that there is no water inside the cap, the optical window is clean and clear, the O-rings are intact and have a thin coating of silicone grease and the spring contacts are clean and undamaged.
- 3 If readings continue to be erratic and unstable, a replacement of the cap or the whole sensor may be necessary.

11.3 Replacement of the OptiOx sensor cap

The sensor cap has a lifespan of 1 year once the first measurement is taken. The meter will display a message "sensor cap expired" when the cap needs to be replaced.

Note

- The OptiOx™ sensor contains an internal clock which counts down the 365 day life span of a new sensor cap. The countdown begins once the OptiOx™ cap has been attached, the sensor connected to the device and the first measurement or calibration carried out. This process cannot be undone once the first measurement has been carried out.
- 1 Pull the expired sensor cap off the sensor without twisting. See fig. A.
 - 2 Remove the existing O-rings from the sensor. See fig. B.
 - 3 Use a lint-free cloth to remove any moisture from the sensor body. Make sure there is no moisture in the O-ring grooves.
 - 4 Use your finger to apply a layer of lubricant around the O-ring grooves. Place the new O-rings on the sensor (included in the delivery of a new sensor cap). Apply another thin layer of lubricant to the O-rings and grooves. Do not transfer grease to the lens or sensor pins.
 - 5 Gently wipe the lens with a clean cloth and allow it to dry thoroughly. Do not wet the lens area with water or any other solution. Examine the lens for scratches or dirt.
 - 6 Install a new OptiOx sensor cap onto the optical sensor by aligning the arrow on the cap with the index mark on the sensor. See fig. C.
Without twisting, firmly press the cap onto the sensor until the cap is flushed with the sensor body. Make sure that the O-rings are not pinched or rolled between the cap and sensor. See fig. D.
 - 7 After replacing the OptiOx sensor cap, a vapor-saturated air calibration should be performed.

Note

- Do not remove the OptiOx cap after installation until a cap replacement is necessary.

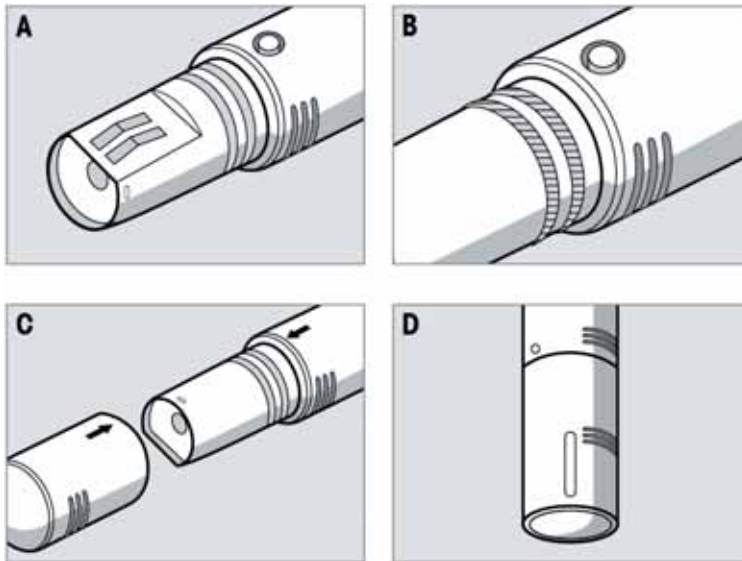

11.4 Interfering substances of the InLab® OptiOx sensor



CAUTION

Damage of the sensor!

Do not use the InLab® OptiOx sensor in solutions that contain organic solvents, such as acetone, chloroform or methylene chloride.

Following substances may interfere with the dissolved oxygen measurement:

- Alcohols greater than 5%,
- Hydrogen peroxide (H₂O₂) greater than 3%,
- Sodium hypochlorite (NaClO₃) greater than 3%,
- Gaseous sulphur dioxide (SO₂) and gaseous chlorine (Cl₂).

Carbone dioxide (CO₂), ammonia (NH₃), pH, any ionic species like sulphide (S²⁻), sulphate (SO₄²⁻), chloride (Cl⁻) and hydrogen sulphide (HS⁻) do not interfere with the dissolved oxygen measurements.

11.5 Software update

A software update can only be done by an authorized METTLER TOLEDO Service agent!

11.6 Repair of the instrument

Seven2Go meters can be repaired. Please ask the METTLER TOLEDO Service department for more information.

11.7 Disposal

In conformance with the European Directive 2002/96/EC on Waste Electrical and Electronic Equipment (WEEE) this device may not be disposed of in domestic waste. This also applies to countries outside the EU, per their specific requirements.

Please dispose of this product in accordance with local regulations at the collecting point specified for electrical and electronic equipment. If you have any questions, please contact the responsible authority or the distributor from which you purchased this device. Should this device be passed on to other parties (for private or professional use), the content of this regulation must also be related.

Thank you for your contribution to environmental protection.



12 Technical Data

General

Power rating (batteries)	Batteries	4 x LR6/AA 1.5 V Alkaline - or - 4 x HR6/AA 1.3 V NiMH rechargeable
	Battery life (Standby)	200... 250 hrs
Power rating (USB powered)	Connection	Micro-USB
	Rating	5 V $\overline{\text{DC}}$, 200 mA
Dimensions	Height	222 mm
	Width	70 mm
	Depth	35 mm
	Weight	290 g
Display	LCD	Graphic LCD display
Interfaces	PC connection	Micro-USB
Ambient conditions	Ambient temperature	0...40 °C
	Relative humidity	5%...85% (non-condensing) at 31 °C, linearly descending to 50% at 40 °C
	Overvoltage category	Class II
	Pollution degree	2
	Maximum operating altitude	Up to 2000 m
	Range of application	For indoor and outdoor use
Materials	Housing	ABS/PC reinforced
	Window	Polymethyl methacrylate (PMMA)
Data security / storage	ISM®	Yes
	Memory size	2000 (GLP conform)

Measurement

Parameters	Dissolved oxygen (digital, RDO)	
Sensor input	DO (digital)	Mini-LTW (IP67)
Dissolved Oxygen	Measuring range	0.00...50.0 mg/L (ppm)
	Resolution	0.01
	Accuracy (with sensor)	± 0.1 mg/L from (0...8 mg/L)
		± 0.2 mg/L (8...20 mg/L)
		$\pm 10\%$ (20...50 mg/L)
Units	mg/L, ppm	
DO Saturation	Measuring range	0.0...500%
	Resolution	0.1
	Accuracy (with sensor)	$\pm 10\%$ of measured value
Pressure	Measuring range	500...1100 mbar
	Resolution	1
	Accuracy (with sensor)	$\pm 2\%$
	Choice of pressure units	mbar, hPa, mmHg, Atm
Temperature	Measuring range	0...50 °C
	Resolution	0.1
	Accuracy (with sensor)	± 0.1 °C
Calibration	Calibration points	2
	Predefined oxygen standards	2

13 Product Portfolio

13.1 Meter and kit versions

Parts	Order No.
Seven2Go optical DO meter S9 ONLY ¹⁾	30207970
S9-Standard Kit with InLab OptiOx™	30207971
S9-Field Kit with InLab OptiOx™, protective guard and uGo carrying case	30207972
S9-BOD Kit with InLab OptiOx™, BOD adapter and uGo carrying case	30207939

¹⁾ **Including:**

- 1 x CD with operating instructions
- 1 x QuickGuide
- 1 x Declaration of conformity
- 1 x Test certificate
- 1 x Wrist strap
- 1 x USB cable
- 1 x Meter base
- 1 x LabX direct CD

13.2 Accessories

Parts	Order No.
uGo™ carrying case	30122300
Seven2Go meter benchtop stabilizing base	30122303
Seven2Go electrode clip and electrode clip covers (4 pcs.)	30137805
Seven2Go wrist strap	30122304
Power adapter for USB cable (to operate instrument without batteries)	30207980
InLab® OptiOx, optical DO sensor (1.8 m cable)	51344621
InLab® OptiOx-5 m, optical DO sensor (5 m cable)	51344622
InLab® OptiOx-10 m, optical DO sensor (10 m cable)	51344623
Replacement Cap OptiOx	51344630
Calibration Tube OptiOx	51344631
Protective Guard OptiOx (stainless steel)	51344632
BOD Adapter OptiOx	51344633
Software	Order No.
LabX®direct pH PC software	51302876
Solutions	Order No.
Zero oxygen tablets (20 pcs.)	51300140

14 Appendix

14.1 Dissolved Oxygen in relation to temperature

The solubility of oxygen in water changes with temperature, the DO content reducing sharply with increase in temperature.

Table according to EN 25814 and UNESCO (partly extrapolated)

Temperature T [°C]	O ₂ solubility [mg/L]
0	14.62
1	14.22
2	13.83
3	13.46
4	13.11
5	12.77
6	12.45
7	12.14
8	11.84
9	11.56
10	11.29
11	11.03
12	10.78
13	10.54
14	10.31
15	10.08
16	9.87
17	9.66
18	9.47
19	9.28
20	9.09
21	8.91
22	8.74
23	8.58
24	8.42
25	8.26
26	8.11
27	7.97
28	7.83
29	7.69
30	7.56
31	7.43
32	7.30
33	7.18
34	7.06
35	6.95
36	6.83
37	6.72
38	6.61
39	6.51
40	6.41
41	6.32
42	6.23

Temperature T [°C]	O₂ solubility [mg/L]
43	6.14
44	6.05
45	5.96
46	5.88
47	5.79
48	5.71
49	5.63
50	5.55
51	5.47
52	5.39
53	5.31
54	5.24
55	5.16
56	5.08
57	5.00
58	4.91
59	4.83
60	4.74

To protect your product's future:

METTLER TOLEDO Service assures the quality, measuring accuracy and preservation of value of this product for years to come.

Please request full details about our attractive terms of service.

www.mt.com/ph

For more information

Mettler-Toledo AG, Analytical

CH-8603 Schwerzenbach, Switzerland

Tel. +41 (0)44 806 77 11

Fax +41 (0)44 806 73 50

www.mt.com

Subject to technical changes.

© Mettler-Toledo AG 08/2014

30219761A

