

METTLER TOLEDO

Table of Contents

1	Introduction	5	
2	Safety Measures	6	
	2.1	Definition of signal warnings and symbols	6
	2.2	Product specific safety notes	6
3	Design and Function	9	
	3.1	Overview	9
	3.2	Sensor connections	9
	3.3	T-Pad and hard keys	10
	3.4	Display and icons	11
	3.5	Setup menu	13
	3.5.1	Navigation	13
	3.5.2	Menu structure	14
4	Putting into Operation	15	
	4.1	Scope of delivery	15
	4.2	Installing the batteries	16
	4.3	Connecting sensors	17
	4.4	Installing optional equipment	18
	4.4.1	Electrode holder	18
	4.4.2	Meter base stabilizing unit	18
	4.4.3	Wrist strap	19
	4.5	Switching the instrument on and off	20
5	Operation of the Instrument	21	
	5.1	Calibration	21
	5.1.1	Buffer groups	21
	5.1.2	Define a user-defined buffer standard	21
	5.1.3	Performing a 1-point calibration	21
	5.1.4	Performing a 2-point calibration	22
	5.1.5	Performing a 3-, 4- or 5-point calibration	22
	5.2	Measurement settings	23
	5.2.1	Measurement resolution	23
	5.2.2	Stability criteria	23
	5.2.3	Endpoint Formats	23
	5.2.4	Timed Interval Reading	24
	5.2.5	Rel. mV Offset	24
	5.3	Sample measurement	24
	5.3.1	Performing a pH measurement	24
	5.3.2	Performing a mV or rel. mV measurement	24
	5.4	Temperature measurement	25
	5.4.1	Automatic temperature capture (ATC)	25
	5.4.2	Manual temperature capture (MTC)	25
	5.5	Using the memory	26
	5.5.1	Storing a measurement result	26
	5.5.2	Recalling from memory	26
	5.5.3	Clearing the memory	26
	5.6	Hot power on/off	27
	5.7	Instrument self-test	27
	5.8	Factory reset	27

6	Maintenance			28
		6.1	Cleaning the housing	28
		6.2	Electrode maintenance	28
		6.3	Error messages	29
		6.4	Disposal	30
7	Technical data			31
8	Product Portfolio			32
9	Accessories			33
10	Appendix			34
		10.1	Buffers	34

1 Introduction

Thank you for purchasing this high quality METTLER TOLEDO portable meter. Everywhere you measure pH, conductivity or dissolved oxygen - the Seven2Go™ portables are designed to offer you fast quality data, one-handed operation and an investment that lasts. Whether you work in the laboratory, at-line or outdoors, the Seven2Go™ meters will provide you with high quality measurement everywhere you go. The Seven2Go™ offers many exciting features, including:

- Simple and intuitive menus that shorten steps needed for setting up measurements and calibration
- T-pad hard keys for comfortable and fast navigation
- Rubber side-guards for comfortable, one-handed operation
- IP67 rating for the entire measurement system, including meter, sensor and the connection cables
- Useful accessories such as the electrode clip, the meter base stabilizing unit, the wrist strap and the uGo™ carrying case with hermetically sealed interior for easy cleaning

2 Safety Measures

2.1 Definition of signal warnings and symbols

Safety notes are marked with signal words and warning symbols. These show safety issues and warnings. Ignoring the safety notes may lead to personal injury, damage to the instrument, malfunctions and false results.

Signal words

WARNING	for a hazardous situation with medium risk, possibly resulting in severe injuries or death if not avoided.
CAUTION	for a hazardous situation with low risk, resulting in damage to the device or the property or in loss of data, or minor or medium injuries if not avoided.
Attention	(no symbol) for important information about the product.
Note	(no symbol) for useful information about the product.

Warning symbols



General hazard



Toxic substance



Inflammable or explosive substance

2.2 Product specific safety notes

Your instrument represents state-of-the-art technology and complies with all recognized safety rules, however, certain hazards may arise in extraneous circumstances. Do not open the housing of the instrument; it does not contain any parts that can be maintained, repaired or replaced by the user. If you ever have problems with your instrument, contact your authorized METTLER TOLEDO dealer or service representative.

Intended use



This instrument is designed for a wide range of applications in various areas and is suitable for measuring pH (S2, S8), conductivity (S3, S7) or dissolved oxygen (S4, S9).

The use therefore requires knowledge and experience in working with toxic and caustic substances as well as knowledge and experience working with application-specific reagents, which may be toxic or hazardous.

The manufacturer shall not be held liable for any damage resulting from incorrect usage divergent to the operating instructions. Furthermore, the manufacturer's technical specifications and limits must be adhered to at all times and in no way exceeded.

Location



The instrument has been developed for indoor and outdoor operation and may not be used in explosive environments.

Use the instrument in a location which is suitable for the operation, protected from direct sunlight and corrosive gases. Avoid powerful vibrations, excessive temperature fluctuations and temperatures below 0 °C and above 40 °C.

Protective Clothing

It is advisable to wear protective clothing in the laboratory when working with hazardous or toxic substances.



A lab coat should be worn.



Suitable eye protection such as goggles should be worn.



Use appropriate gloves when handling chemicals or hazardous substances, checking their integrity before use.

Safety notes



WARNING

Chemicals

All relevant safety measures are to be observed when working with chemicals.

- a) Set up the instrument in a well-ventilated location.
 - b) Any spills should be wiped off immediately.
 - c) When using chemicals and solvents, comply with the instructions of the producer and the general lab safety rules.
-



WARNING

Flammable solvents

All relevant safety measures must be observed when working with flammable solvents and chemicals.

- a) Keep all sources of flame away from the workplace.
 - b) When using chemicals and solvents, comply with the instructions of the producer and the general lab safety rules.
-

FCC Rules

This device complies with Part 15 of the FCC Rules and Radio Interference Requirements of the Canadian Department of Communications. Operation is subject to the following conditions: (1) this device may not cause harmful interference, and (2) this device must accept any interference received, including interference that may cause undesired operation.

This equipment has been tested and found to comply with the limits for a Class A digital device, pursuant to Part 15 of the FCC rules. These limits are designed to provide reasonable protection against harmful interference when the equipment is operated in a commercial environment. This equipment generates, uses, and can radiate radio frequency energy and, if not installed and used in accordance with the instruction manual, may cause harmful interference to radio communications. Operation of this equipment in a residential area is likely to cause harmful interference in which case the user will be required to correct the interference at his own expense.

3 Design and Function

3.1 Overview

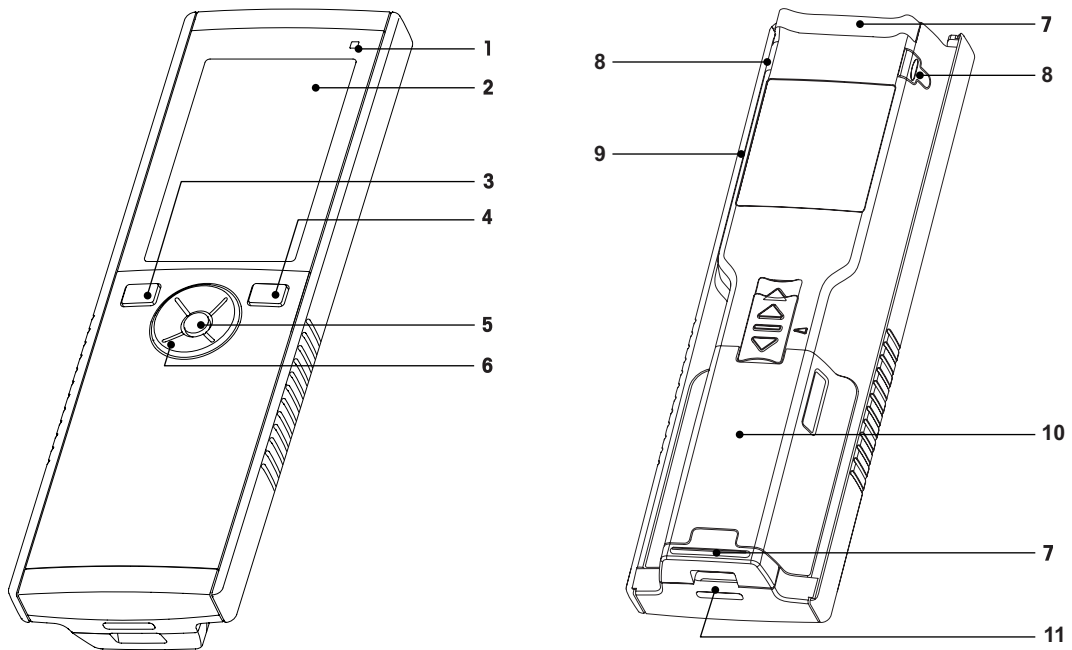

- 1** Status LED (only Pro-series)
- 2** Display
- 3** Calibration key
- 4** On/Off key
- 5** Read key
- 6** T-Pad

- 7** Rubber feet
- 8** Fixing points for electrode holder
- 9** Micro-USB port (only Pro-series)
- 10** Battery compartment
- 11** Slot for wrist strap

3.2 Sensor connections

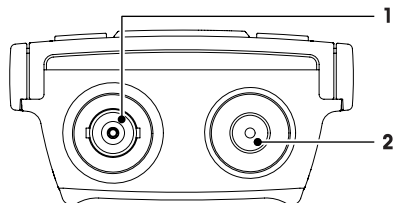

- 1** BNC socket for mV/pH signal input
- 2** RCA (Cinch) socket for temperature input

3.3 T-Pad and hard keys

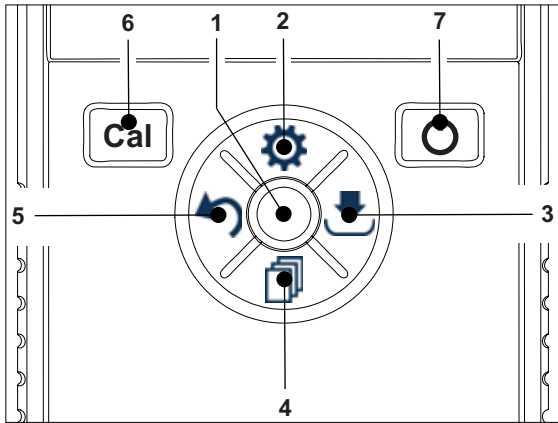









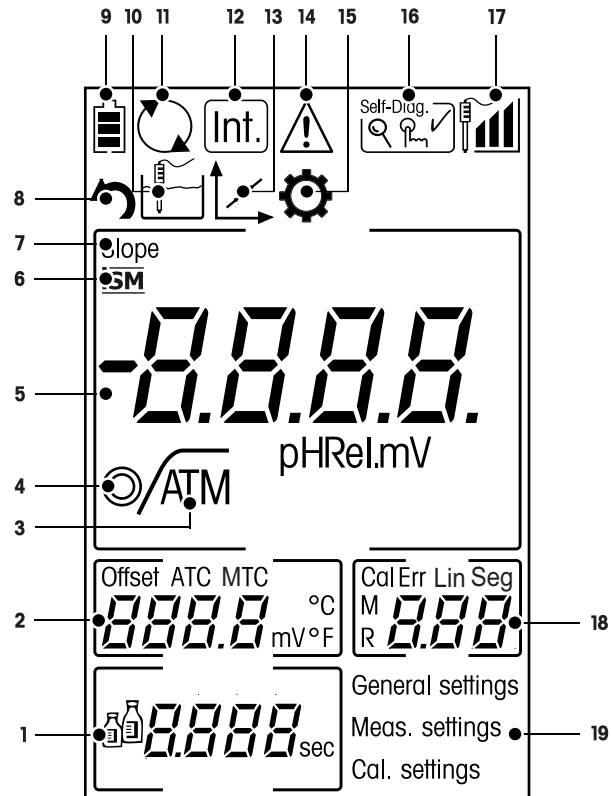















	Name	Function	Press (in measurement screen)	Press (other screens)
1	Read	Read/Take manual endpoint	•	
		Confirm		•
2	⚙️	Open Setup menu	•	
		Edit value (Increase)		•
3	➡️	Save	•	
		Direction Right		•
4	📄	Switch measurement mode	•	
		Edit value (Decrease)		•
5	↶	Recall last measurement data	•	
		Exit		• • > 1 s (editing mode) • > 1 s to exit (calibration mode)
		Direction Left		•
6	Cal	Enter Calibration Mode	•	
		Calibration Recall	• > 1 s	
7	⏻	On/Off	• 1 s for on • 3 s for on	• 1 s for on • 3 s for on

3.4 Display and icons

When turning on the instrument, the startup screen appears for 3 seconds. The startup screen shows all icons which can appear on the display. In the following table you find a short description about these icons.

Startup screen





	Icon	Description
1		Buffer/Standard settings
2	---	Offset reading
3		Endpoint format \sqrt{A} Automatic \sqrt{T} Timed \sqrt{M} Manual
4		Stability criteria (pH only) ○ fast ● normal
5	---	pH/mV reading
6		ISM sensor has been detected and is properly connected
7	SLOPE	Slope is one of two quality indicators for the attached sensor and is determined during calibration. Refer to the InLab® sensor's quality certificate for more information.
8		Recall mode
9		Power status  fully charged  half-charged  lowly-charged  fully discharged
10		Measurement mode
11		Hot power on (Instrument never shuts down automatically until power is used up or the On/Off button is pressed manually)
12	Int.	Timed interval reading mode active
13		Calibration mode Indicates calibration mode and appears whenever you are performing a calibration or reviewing calibration data.
14		Error occurred
15		Setup mode
16	Self-Diag. 	Self-diagnosis mode  Self-diagnosis indicator  Indication to press key  Self-diagnosis passed
17		Electrode performance  Slope: 95-105% / Offset: ± 0-15 mV (Electrode in good condition)  Slope: 90-94% / Offset: ± 15-35 mV (Electrode needs cleaning)  Slope: 85-89% / Offset: > 35 mV (Electrode is faulty)
18	---	Calibration point / Error messages
19	---	Main Menu structure





3.5 Setup menu

3.5.1 Navigation

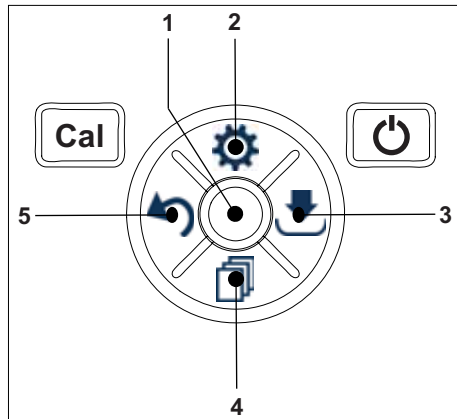
For general navigation in the setup menu read the following information:

- Press  to enter the setup menu.
- Press and hold  to exit the setup menu.
- Press **Read** to confirm a change.
- Press and hold **Read** to exit the setup menu and return directly to the measurement screen from every position in the setup menu.



- 1 --- Read**
 - Read / save cal data
 - Confirm entered values
- 2  Setup / Up**
 - Enter the setup menu.
 - Move up in the menu structure.
 - Edit value (increase).
- 3  Save / Right**
 - Save measurement data.
 - Store last calibration point to end calibration.
 - Go right.
- 4  Mode / Down**
 - Change measurement mode.
 - Move down in the menu structure.
 - Edit value (decrease).
- 5  Recall / Left**
 - Recall data / recall the last step.
 - Go left.
 - For menu or data memory exit (press >1 s).

3.5.2 Menu structure

1.	General Settings
1.	Temperature Settings
1.2	Cal 1
1.3	Cal 2
2.	Stability Criterion
2.1	Fast
2.2	Normal
3.	Endpoint Formats
3.1	Automatic
3.2	Timed
3.2.1	Measurement Time
3.3	Manual
2.	Measurement Settings
1.	Interval Time
2.	Resolution
3.	Rel.mV
3.	Calibration Settings
1.	Set Buffer Group
1.1	Buffer 1
1.1.1	Linear Segmented
1.2	Buffer 2
1.2.1	Linear Segmented
1.3	Buffer 3
1.3.1	Linear Segmented
1.4	Buffer 4
1.4.1	Linear Segmented
1.5	Buffer 5
1.5.1	Linear Segmented

4 Putting into Operation

4.1 Scope of delivery

Check the completeness of the delivery. The following accessories are part of the standard equipment of your new instrument:

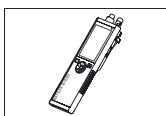

S2 instrument
for pH/mV measurement

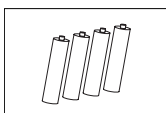

Battery LR3/AA 1.5V
4 pcs.



Electrode holder



CD-ROM including operating instructions

4.2 Installing the batteries

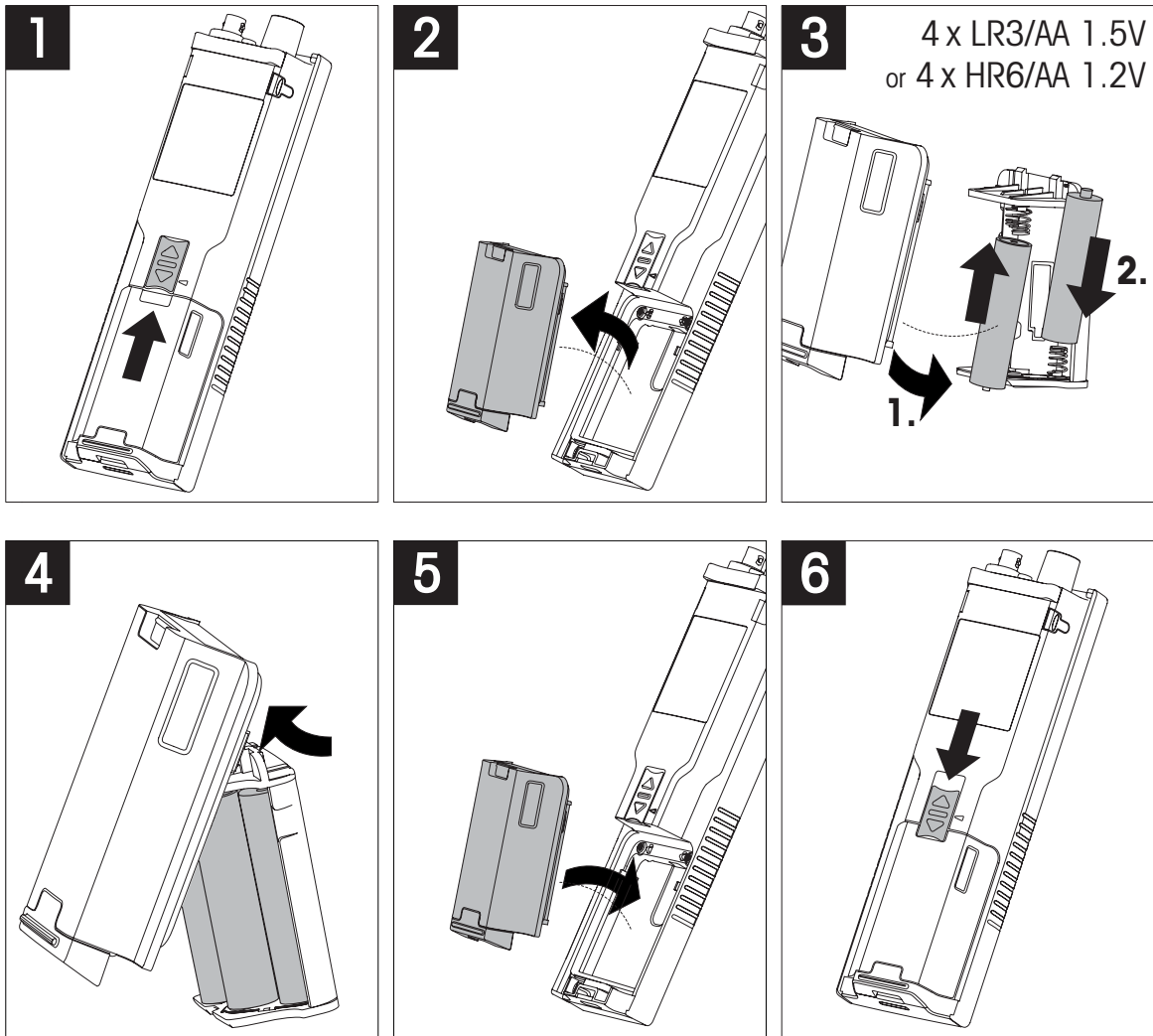

4.3 Connecting sensors

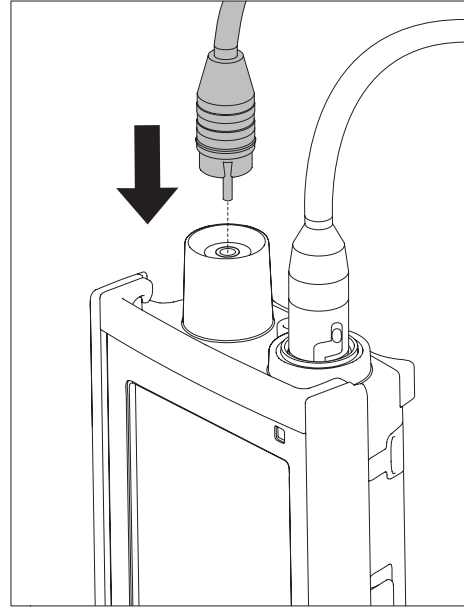
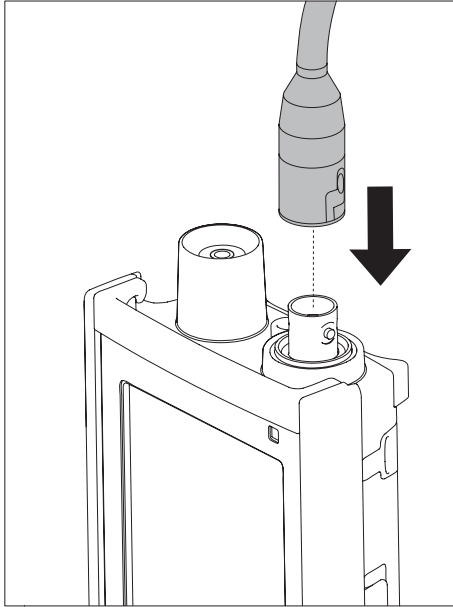

ISM® sensor

When connecting an ISM® sensor to the meter, one of the following conditions has to be met for the calibration data to be transferred automatically from the chip of the sensor into the meter and usage for further measurements. After attaching the ISM® sensor the following steps must be followed:

- Switch on the meter.
- Press **Read** key or press **Cal** key.

The icon **ISM** appears on the display. The sensor ID of the sensor chip is registered and appears on the display. The calibration history and the sensor-data can be reviewed in the data menu.

Note

- We strongly recommend to switch off the meter when disconnecting an ISM sensor! In doing so, you make sure that the sensor is not removed while the instrument is reading data from or writing data to the ISM-chip of the sensor.

4.4 Installing optional equipment

4.4.1 Electrode holder

For a safe placing of the electrode you can mount an electrode holder on the side of the instrument. The electrode holder is part of delivery. You can mount it on either sides of the instrument for your personal handling.

- 1 Remove the protective clips (1).

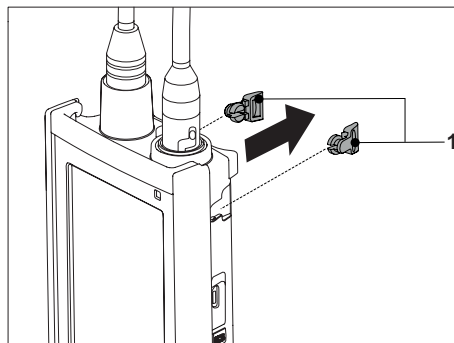

- 2 Push the electrode holder (1) into the recess (2) of the instrument.

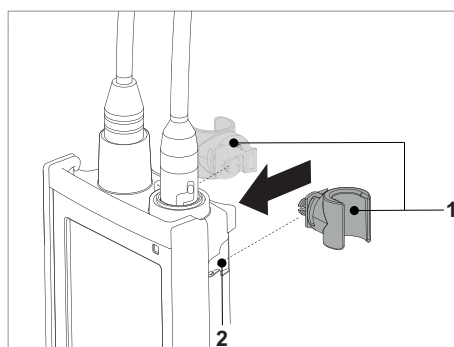

4.4.2 Meter base stabilizing unit

The meter base stabilizing unit should be mounted when using the instrument on a desk. It ensures a more firm and secure stand when pressing the keys.

- 1 Remove the protective clips (1).

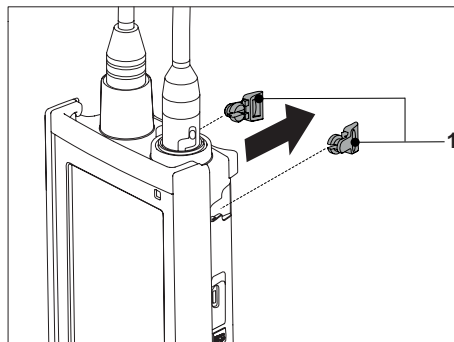

- 2 Push the meter base stabilizing unit (1) into the recesses (2) of the instrument.

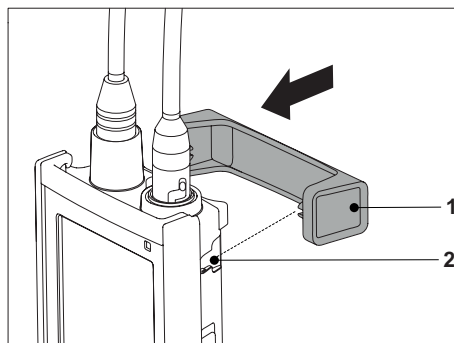

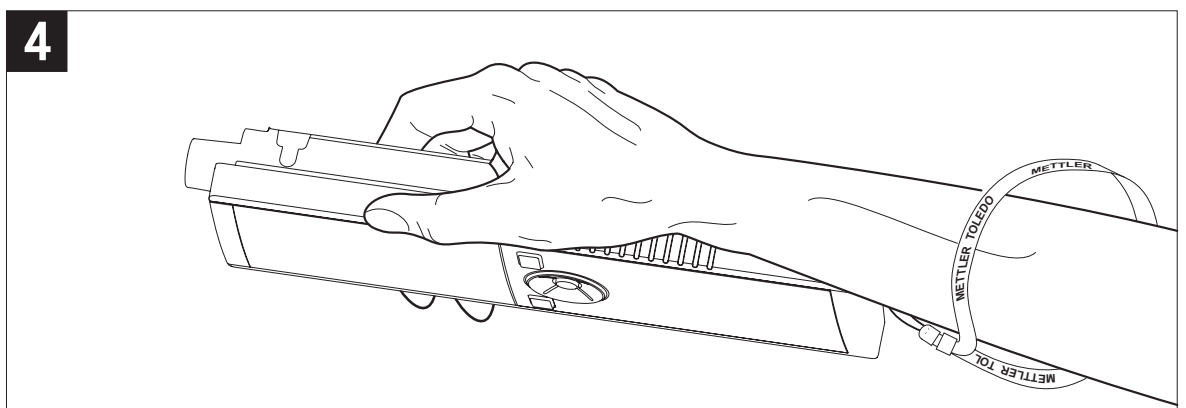
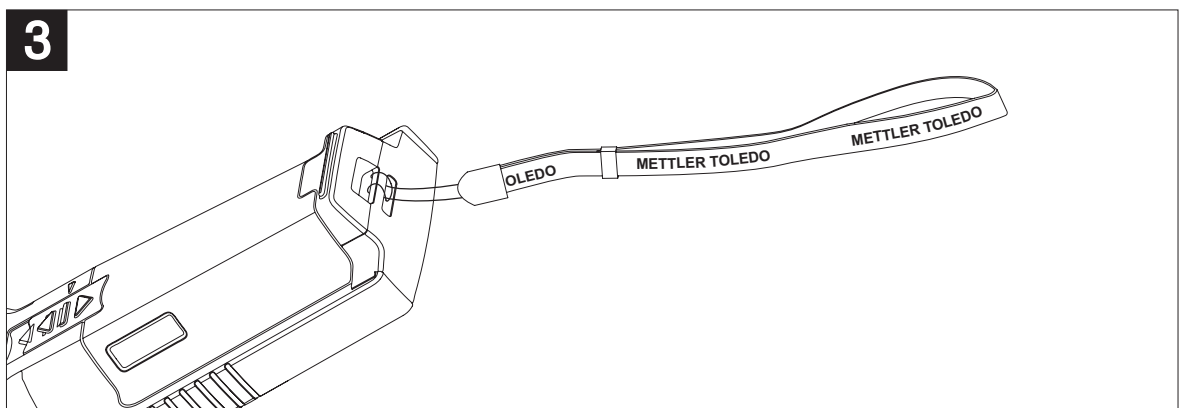
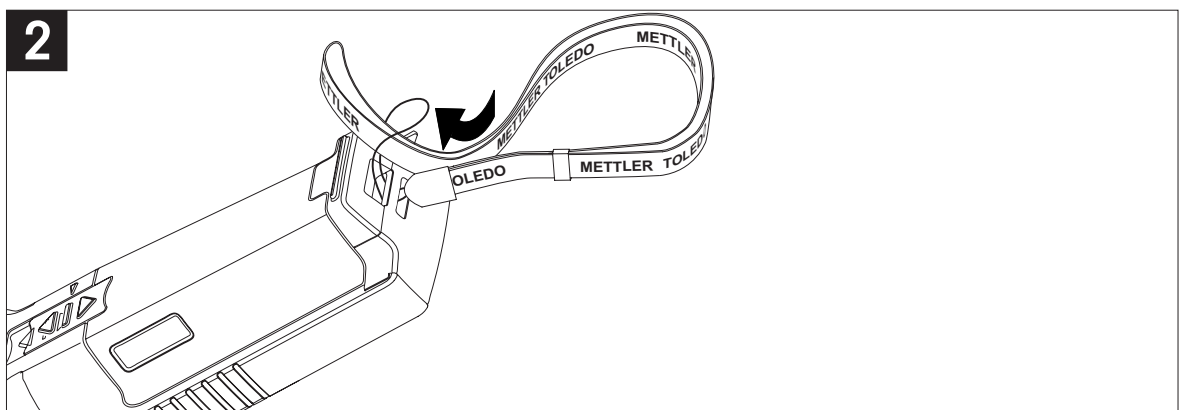
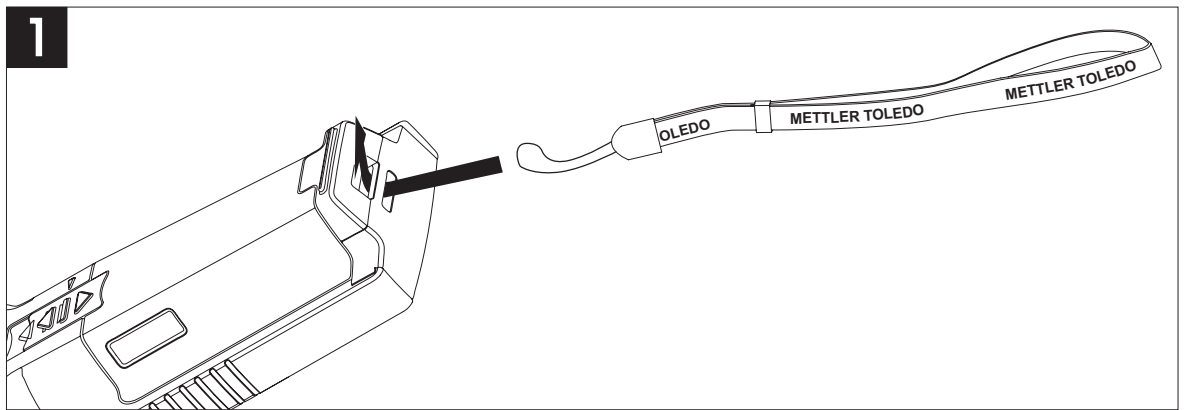

4.4.3 Wrist strap

For better protection against damage caused by dropping, you can mount the wrist strap as shown in the following diagrams.



4.5 Switching the instrument on and off

- 1 Press and release  to switch on the instrument.
 - ⇒ All segmented digital numbers and icons are displayed for 2 seconds. After that the installed software version appears (e.g. 1.00) and the instrument is ready for use.
- 2 Press  for 2 seconds and release to switch off the instrument.

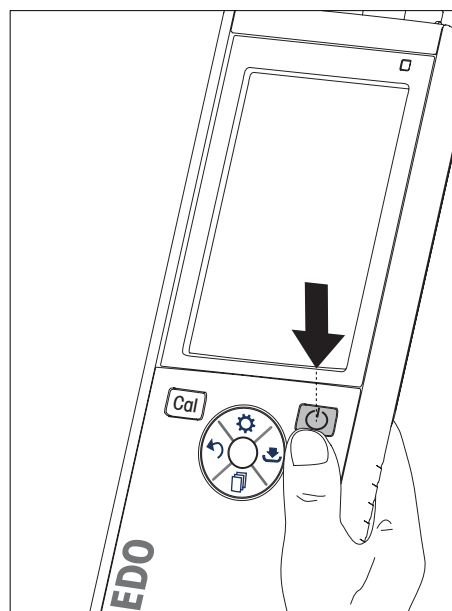

Note

- By default after 10 minutes not in use, the instrument shuts down automatically. The auto-off function can be turned on/off in the setup menu, under **General settings**.

See also

- Hot power on/off (page 27)

5 Operation of the Instrument

5.1 Calibration

Note

- The use of a temperature sensor or electrode with a built-in temperature sensor is recommended.
- If you use the **MTC** mode, you should enter the correct temperature value and keep all buffer and sample solutions at the set temperature.
- To ensure the most accurate pH readings, you should perform a calibration regularly.

5.1.1 Buffer groups

The Seven2Go™ S2 pH/mV meter allows you to perform 1-, 2-, 3-, 4- and 5-point calibrations. If you select your calibration buffer group from one of the four predefined groups defined in the meter, the buffers are automatically recognized and displayed during calibration (auto buffer recognition). The following table shows the predefined buffer groups.

B1	7.00	4.01	10.01	1.68		@ 25°C
B2	7.00	4.01	9.21	2.00	11.00	@ 25°C
B3	7.00	4.00	9.00	2.00	12.00	@ 20°C
B4	6.860	4.003	9.182	1.680	12.460	@ 25°C

Tables (B1...B4) for automatic temperature compensation are programmed in the meter. You can also follow the buffer setting procedure described below to define your own buffer group, but in this case auto buffer recognition does not work during calibration.

















See also

- Appendix (page 34)

5.1.2 Define a user-defined buffer standard

Buffer Groups 1 - 4 are fixed. The composition of these buffer groups can be found in the Appendix. Buffer Group 5 is changeable (user-defined) and can store up to 5 customized buffers.

To define up to five user-defined buffers, follow these steps:

- 1 Press  to enter the setup menu.
- 2 Select **Calibration Settings** and press **Read**.
- 3 Select **Buffer Group 5** by using  or .
- 4 Press  to confirm and move to the temperature values.
- 5 Change the temperature value by using  or .
- 6 Press  to confirm and move to the temperature unit.
- 7 Change the temperature unit by using  or .
- 8 Press  to confirm and move to the first buffer in the user-defined buffer group.
- 9 Press  again to enter the buffer values and change the buffer value by using  or .
- 10 Press  to confirm and move back to buffer.
- 11 Change buffer by using  or  and repeat step 9 and 10 for the remaining buffers.
- 12 Press **Read** to confirm.
- 13 Press and hold  to exit the setup menu.

Note

When entering the user-defined buffer value, the meter does not accept a value which pH differs by less than 1 pH unit from other preset values.

5.1.3 Performing a 1-point calibration

- ▶ An electrode is connected to the instrument.

- 1 Place the electrode in a calibration buffer and press **Cal** to start the calibration.
 - ⇒ The S2 endpoints according to the preselected measurement mode (timed, manual or auto). After the signal has stabilized or after pressing **Read** (manual endpoint) the meter displays and freezes the relevant buffer value.
 - ⇒ The offset value and the slope are then shown on the display.
- 2 Press **Read** to accept the calibration and return to sample measurement.
- 3 Press **Exit** to reject the calibration.

Note

- With the 1-point calibration only the offset is adjusted. If the sensor was previously calibrated with multi-point calibration the previously stored slope will remain. Otherwise the theoretical slope (59.16 mV/pH) will be used.

5.1.4 Performing a 2-point calibration

- ▶ An electrode is connected to the instrument.
- 1 Perform the first point calibration as described in the section Performing a 1-point calibration (page 21).
 - 2 Rinse the electrode with deionized water.
 - 3 Place the electrode in the next calibration buffer and press **Cal** to start the calibration.
 - ⇒ The S2 endpoints according to the preselected measurement mode (timed, manual or auto). After the signal has stabilized or after pressing **Read** (manual endpoint) the meter displays and freezes the relevant buffer value, updates the electrode offset and shows the new slope calculated from the two calibration points.
 - 4 Press **Read** to accept the calibration and return to sample measurement.
 - 5 Press **Exit** to reject the calibration.







5.1.5 Performing a 3-, 4- or 5-point calibration

- ▶ An electrode is connected to the instrument.
- 1 Perform the same steps as described in the section Performing a 2-point calibration (page 22).
 - 2 Repeat steps 2 and 3 of the section Performing a 2-point calibration (page 22) for the third, then the fourth, and finally the fifth-point calibration.

5.2 Measurement settings

5.2.1 Measurement resolution

You can define the resolution for your pH measurement in the Measurement Settings.





- 1 Press  to enter the setup menu.
- 2 Select **Measurement Settings** and press **Read** twice.
- 3 Choose the resolution using  or  (0.01 or 0.1).
- 4 Choose the resolution by using  or  (0.01 or 0.1).
- 5 Press **Read** to confirm.
- 6 Press and hold  to exit the setup menu.

5.2.2 Stability criteria

You can set 2 different stability criterias on your S2 device:

- **Fast** :
Value varies less than 1 mV which corresponds to 0.1 pH
- **Normal** :
Value varies less than 0.5 mV which corresponds to 0.05 pH

You can define the stability criteria for your pH measurement in the Measurement Settings.

- 1 Press  to enter the setup menu.
- 2 Select **General Settings** and press **Read** twice.
- 3 Choose the stability criterion by using  or .
- 4 Press **Read** to confirm.
- 5 Press and hold  to exit the setup menu.

5.2.3 Endpoint Formats

The Seven2Go™ offers three different endpoint formats:

Automatic endpoint:





With the automatic endpoint the selected stability criterion (fast, normal) determines the end of an individual reading depending on the behavior of the sensor used. This ensures an easy, quick, and precise measurement.

Timed endpoint:

The measurement stops after a user-defined period of time (5 s - 3600 s).





Manual endpoint:

Unlike Auto, user interaction is required to stop the measurement reading in manual mode. The three different endpoint formats can be selected in the General settings.

- 1 Press  to enter the setup menu.
- 2 Select **General Settings** and press **Read** twice.
- 3 Choose the endpoint format by using  or .
- 4 Press **Read** to confirm.
- 5 Press and hold  to exit the setup menu.





5.2.4 Timed Interval Reading

A reading is taken every time after a certain interval (1 - 200 s) defined in the menu has elapsed. When working in the **Timed Interval Readings** mode, the interval can be defined by entering the seconds. The measurement series stops according to the selected endpoint format (**Automatic**, **Manual**, or **Timed**). When **Timed Interval Readings** is **On**, Int. appears on the screen.

- 1 Press  to enter the setup menu.
- 2 Select **Measurement Settings** and press **Read**.
- 3 Choose interval time by using  or .
- 4 Press **Read** to confirm.
- 5 Press and hold  to exit the setup menu.

5.2.5 Rel. mV Offset

In the **Rel. mV Offset** mode, the offset value is subtracted from the measured value. Either an offset value can be entered (-1999 ... +1999) or it can be determined by measuring the mV of a reference sample.

- 1 Press  to enter the setup menu.
- 2 Select **Measurement Settings** and press **Read** three times.
- 3 Choose the offset value by using  or .
- 4 Press **Read** to confirm.
- 5 Press and hold  to exit the setup menu.

5.3 Sample measurement

5.3.1 Performing a pH measurement

- ▶ A sensor is connected to the instrument.
- ▶ The measurement parameters are fully set.
- Place the electrode in the sample and press **Read** to start the measurement.
 - ⇒ The decimal point blinks.
 - ⇒ The display shows the pH of the sample.
 - ⇒ The automatic endpoint **A** is the default setting of the meter.
 - ⇒ When the signal has stabilized, the display freezes automatically, $\overline{\text{A}}$ appears and the decimal point stops blinking.

Note

- Press and hold down **Read** to switch between the automatic and manual endpoint modes.
- Press **Read** to manually endpoint a measurement. The display freezes and $\overline{\text{M}}$ appears.
- **Stability criterion for pH and mV measurement** = The signal of the sensor input must not change by more than 1 mV during the last 4 s when **Fast** is chosen or 0.5 mV during the last 6 s when **Standard** is chosen.

5.3.2 Performing a mV or rel. mV measurement

- ▶ A sensor is connected to the instrument.
- ▶ The measurement parameters are fully set.
- 1 Press  repeatedly until the relevant unit (mV or rel. mV) is displayed.
- 2 Perform the same steps as described in the section Performing a pH measurement (page 24).

5.4 Temperature measurement

5.4.1 Automatic temperature capture (ATC)





For better accuracy, we recommend the use of either a built-in or a separate temperature probe. If a temperature probe is used, **ATC** and the sample temperature will be displayed.

Note

- The meter accepts NTC 30 kΩ temperature sensors.

5.4.2 Manual temperature capture (MTC)

If the meter does not detect a temperature probe, it automatically switches to the manual temperature capture mode and **MTC** will be displayed. To set the **MTC** temperature follow these steps:

- 1 Press  to enter the setup menu.
- 2 Select **Measurement Settings** and press **Read**.
- 3 Increase or decrease the temperature value for MTC by using  or .
- 4 Press **Read** to confirm.
- 5 Press and hold  to exit the setup menu.

Note

- The default temperature setting is 25 °C.
- The temperature capture works identical, no matter if the temperature is measured (ATC) or manually entered (MTC).

5.5 Using the memory

5.5.1 Storing a measurement result

The Seven2Go™ can store up to 200 endpointed results.

- Press  when the measurement has endpointed.
 - ⇒ **M0001** indicates that one result has been stored, and **M2000** that the maximum of 200 results have been stored.



Note

- If you press  when **M2000** is displayed, **FUL** indicates that the memory is full. To store further data you will have to clear the memory.





See also

- Clearing the memory (page 26)

5.5.2 Recalling from memory

- 1 Press  to recall the stored values from memory when the current measurement has endpointed.
- 2 Press  or  to scroll through the stored results.
 - ⇒ **R0001** to **R2000** indicates which result is currently displayed.
- 3 Press **Read** to exit.



5.5.3 Clearing the memory

- 1 Press  to recall the stored values.
- 2 Press  or  to scroll through the stored results until **ALL** appears.
- 3 Press **Read**.
 - ⇒ **CLr** blinks on the display.
- 4 Press **Read** to confirm the deletion or long-press  to cancel.



5.6 Hot power on/off

Generally the instrument shuts down automatically after 10 minutes of not in use. This is for saving battery life. With **hot power on** you can deactivate this setting. If **hot power on** is active, the instrument will never power off until battery power is used up or the user presses  manually.

Activate hot power on:

- Press  and **Read** simultaneously.
 - ⇒ **Hot power on** is activated,  appears on the display.



Deactivate hot power on:

- Press  and **Read** simultaneously.
 - ⇒ **Hot power on** is deactivated,  disappears from the display.

Note

On delivery and after doing a factory reset, the **hot power on** function is OFF.

5.7 Instrument self-test

- 1 Press **Read** and **Cal** simultaneously until  appears.
 - ⇒ First that each icon blinks one after the other whereby you can check if all icons are correctly shown on the display. After that, the full screen will be displayed.
 - ⇒ After that, , starts to blink and the 7 hardkey-icons are shown on the display.
- 2 Press any hardkey.
 - ⇒ The specific icon disappears from the display.
- 3 Press each hardkey one time.
 - ⇒ When the self-diagnosis is completed successfully, **PAS** and  appears. If the self-diagnosis is failed, **Err 1** appears.

Note

- You must press all hardkeys within 2 minutes. Otherwise **Err 1** appears and the self-diagnosis has to be redone.



5.8 Factory reset



Note

Loss of data!

With a factory reset all user-specific settings will be set to standard. Also all data memories (e.g. sample IDs, User IDs) will be deleted.

- ▶ The instrument is switched on.
- 1 Press **Read** and  simultaneously.
 - ⇒ **RST** appears on the display.
- 2 Press .
 - ⇒ The instrument switches off.
 - ⇒ All settings are reset.
- 3 Press  to switch on the instrument.

6 Maintenance

6.1 Cleaning the housing



Note

Damage to the instrument!

Ensure that no liquid enters the interior of the instrument.
Wipe off any spills immediately.

The meters do not require any maintenance other than an occasional wipe with a damp cloth. The housing is made of acrylonitrile butadiene styrene/polycarbonate (ABS/PC). This material is sensitive to some organic solvents, such as toluene, xylene and methyl ethyl ketone (MEK).

- Clean the housing of the instrument using a cloth dampened with water and a mild detergent.

6.2 Electrode maintenance

- Make sure pH electrodes are always kept filled with the appropriate filling solution.
- For maximum accuracy, any filling solution that may have crystallized and encrusted the outside of the electrode should be removed with deionized water.
- Always store the electrode according to the manufacturer's instructions and do not allow it to dry out.

If the electrode slope falls rapidly, or if the response becomes sluggish, the following procedures may help. Try one of the following, depending on your sample. Run a new calibration after treatment.

Symptom	Procedure
Fat or oil build-up.	Degrease the membrane with cotton wool soaked in either acetone or a soap solution.
Membrane has dried out.	Soak the tip of the electrode overnight in 0.1 M HCl.
Protein build-up in the diaphragm.	Remove deposits by soaking the electrode in an HCl/pepsin solution.
Silver sulfide contamination.	Remove deposits by soaking electrode in a thiourea solution.

Note

- Cleaning and filling solutions should be handled with the same care as that given to toxic or corrosive substances.

6.3 Error messages

Error 0	Error to access memory	<ul style="list-style-type: none"> • Switch Seven2Go off and on again. • If this error persists, call METTLER TOLEDO Service.
Error 1	Self-diagnosis failed: Not all key presses recognized within 2 minutes	<ul style="list-style-type: none"> • Repeat the self-diagnosis procedure and make sure that you finish pressing all seven keys within two minutes. • If the error appears again, call METTLER TOLEDO Service.
Error 2	pH or mV reading is outside specified range (see technical data in chapter 9)	<ul style="list-style-type: none"> • Make sure that the electrode's wetting cap has been removed. • Make sure the electrode is placed in the sample solution. • Check the calibration data. If needed, re-calibrate the electrode. • Check if the electrode is properly connected. Neither the electrode plug nor the instrument's connector must be oxidized. • Verify that all pins of the electrode cable plugs are straight (not bent). • To exclude a problem with the meter, connect the shortening plug to the BNC connector and measure the mV reading; it must be 0 ± 1 mV. • To check the goodness of the pH electrode, measure the mV readings in pH buffers 4
Error 3	Measured temperature during calibration is outside range $0 \dots +50$ °C	<ul style="list-style-type: none"> • Keep the buffer temperature within the range for calibration. • To check the temperature reading, perform a measurement in the wetting cap at room temperature and verify correct reading.
Error 4	Calculated offset value after calibration is outside range $-60 \dots +60$ mV	<ul style="list-style-type: none"> • Make sure you have the correct buffer and that it is fresh. • Make sure you have selected the correct buffer group in the settings. • To check the goodness of the pH electrode, measure the mV readings in pH buffers 4 and 7. Values of 180 ± 30 mV and 0 ± 30 mV are expected. • Clean or replace the electrode.
Error 5	Calculated slope value after calibration is outside range $85 \dots +110$ %	<ul style="list-style-type: none"> • Make sure you have the correct buffer and that it is fresh. • Make sure you have selected the correct buffer group in the settings. • To check the goodness of the pH electrode, measure the mV readings in pH buffers 4 and 7. Values of 180 ± 30 mV and 0 ± 30 mV are expected. • Clean or replace the electrode.

Error 6	Meter cannot recognize the buffer or the recognized buffer was already used in a previous calibration point	<ul style="list-style-type: none"> • Make sure you have the correct buffer and that it is fresh. • Check that the buffer has not been used more than once during the calibration. • To check the goodness of the pH electrode, measure the mV readings in pH buffers 4 and 7. Values of 180 ± 30 mV and 0 ± 30 mV are expected. • Clean or replace the electrode.
Error 7	User-defined buffer error: When entering the user-defined buffer value, the meter does not accept a value whose pH differs by less than 1 pH unit from other preset values.	<ul style="list-style-type: none"> • Enter a pH value following the mentioned rule.
Error 9	Measurement data cannot be stored twice	<ul style="list-style-type: none"> • Measured value has already been stored.
Error 10	Memory is full	<ul style="list-style-type: none"> • Already 200 results have been saved. • Delete some results or clear the memory.

6.4 Disposal

In conformance with the European Directive 2002/96/EC on Waste Electrical and Electronic Equipment (WEEE) this device may not be disposed of in domestic waste. This also applies to countries outside the EU, per their specific requirements.



Please dispose of this product in accordance with local regulations at the collecting point specified for electrical and electronic equipment. If you have any questions, please contact the responsible authority or the distributor from which you purchased this device. Should this device be passed on to other parties (for private or professional use), the content of this regulation must also be related.

Thank you for your contribution to environmental protection.

7 Technical data

General

Power requirements	Batteries	4 x LR6/AA 1.5 V Alkaline - or - 4 x HR6/AA 1.3 V NiMH rechargeable
	Battery life	250...400 h
Dimensions	Height	222 mm
	Width	70 mm
	Depth	35 mm
	Weight	270 g
Display	LCD	Segmented LCD, b/w
Ambient conditions	Operating temperature	0...40°C
	Relative humidity	5%...85% (non-condensing) at 31 °C, linearly descending to 50% at 40 °C
	Overvoltage category	Class II
	Pollution degree	2
	Maximum operating altitude	Up to 2000 m
	Range of application	For indoor and outdoor use
Materials	Housing	ABS/PC reinforced
	Window	Polymethyl methacrylate (PMMA)
	IP Protection class	IP67

Measurement

Parameters	pH, mV, rel. mV	
Sensor inputs	pH/mV	BNC
	Temperature	RCA cinch
pH	Measuring range	-2...20
	Resolution	0.01
	Accuracy (sensor input)	± 0.01
ORP, Redox	Measuring range	-1999...1999 mV
	Resolution	1 mV
	Limits of error	±1 mV
	Units	mV, rel. mV
Temperature	Measuring range	-5...105°C
	Resolution	0.1°C
	Limits of error	± 0.5°C of measured value
	ATC/MTC	Yes
Calibration	Calibration points	5
	Predefined buffer groups	4
	User-defined buffer groups (5 buffers)	1
	Automatic buffer recognition	Yes
	Calibration methods	Linear, segmented
Data security / storage	ISM® (light version)	Yes
	Memory size	200

8 Product Portfolio

Meter and Kits	Order No.
Seven2Go pH/mV meter S2 ONLY	30207949
S2-Standard Kit Seven2Go pH/mV meter S2-Standard Kit with InLab® Expert Pro-ISM®-IP67	30207950
S2-Field Kit Seven2Go pH/mV meter S2-Field Kit with InLab® Expert Pro-ISM-IP67 and uGo™ carrying case	30207951
S2-Food Kit Seven2Go pH/mV meter S2-Food Kit with InLab® Solids Pro-IP67 and uGo™ carrying case	30207952
S2-Light Kit Seven2Go pH/mV meter S2-Light Kit with InLab® Versatile Pro	30207953

9 Accessories

Parts	Order No.
uGo™ carrying case	30122300
Seven2Go meter benchtop stabilizing base	30122303
Seven2Go electrode clip and electrode clip covers (4 pcs.)	30137805
Seven2Go wrist strap	30122304
InLab® Expert Pro-ISM-IP67, 3-in-1 pH sensor, PEEK shaft, ATC, low-maintenance	51344102
InLab® Solids Pro-IP67, 3-in-1 pH sensor, glass shaft, puncture electrode tip, ATC, low-maintenance	51343156
InLab®Routine Pro-ISM, 3-in-1 pH sensor, glass shaft, ATC, refillable	51344055
InLab® Versatile Pro, 3-in-1 pH sensor, Polysulfone shaft, ATC, refillable	51343031
Solutions	Order No.
pH 2.00 buffer sachets, 30 x 20 mL	30111134
pH 2.00 buffer solution, 250 mL	51350002
pH 2.00 buffer solution, 6 x 250 mL	51350016
pH 4.01 buffer sachets, 30 x 20 mL	51302069
pH 4.01 buffer solution, 250 mL	51350004
pH 4.01 buffer solution, 6 x 250 mL	51350018
pH 7.00 buffer sachets, 30 x 20 mL	51302047
pH 7.00 buffer solution, 250 mL	51350006
pH 7.00 buffer solution, 6 x 250 mL	51350020
pH 9.21 buffer sachets, 30 x 20 mL	51302070
pH 9.21 buffer solution, 250 mL	51350008
pH 9.21 buffer solution, 6 x 250 mL	51350022
pH 10.01 buffer sachets, 30 x 20 mL	51302079
pH 10.01 buffer solution, 250 mL	51350010
pH 10.01 buffer solution, 6 x 250 mL	51350024
pH 11.00 buffer sachets, 30 x 20 mL	30111135
pH 11.00 buffer solution, 250 mL	51350012
pH 11.00 buffer solution, 6 x 250 mL	51350026
Rainbow sachets I (10 sachets of pH 4.01 / 7.00 / 9.21)	51302068
Rainbow sachets II (10 sachets of pH 4.01 / 7.00 / 10.00)	51302080
Rainbow bottles I (2 x 250 mL of pH 4.01 / 7.00 / 9.21)	30095312
Rainbow bottles II (2 x 250 mL of pH 4.01 / 7.00 / 10.00)	30095313
InLab storage solution (for all InLab pH and redox electrodes), 250 mL	30111142
Electrolyte 3 mol/L KCl, 25 mL	51343180
Electrolyte 3 mol/L KCl, 250 mL	51350072
Electrolyte 3 mol/L KCl, 6 x 250 mL	51350080
HCl/Pepsin solution (removes protein contamination), 250 mL	51350100
Regeneration solution for pH electrodes, 25 mL	51350104
Thiourea solution (removes silver sulfide contamination), 250 mL	51350102

10 Appendix

10.1 Buffers

METTLER TOLEDO USA (Ref. 25°C)

T [°C]	1.68	4.01	7.00	10.01
5	1.67	4.00	7.09	10.25
10	1.67	4.00	7.06	10.18
15	1.67	4.00	7.04	10.12
20	1.68	4.00	7.02	10.06
25	1.68	4.01	7.00	10.01
30	1.68	4.01	6.99	9.97
35	1.69	4.02	6.98	9.93
40	1.69	4.03	6.97	9.89
45	1.70	4.04	6.97	9.86
50	1.71	4.06	6.97	9.83

METTLER TOLEDO Europe (Ref. 25°C)

T [°C]	2.00	4.01	7.00	9.21	11.00
5	2.02	4.01	7.09	9.45	11.72
10	2.01	4.00	7.06	9.38	11.54
15	2.00	4.00	7.04	9.32	11.36
20	2.00	4.00	7.02	9.26	11.18
25	2.00	4.01	7.00	9.21	11.00
30	1.99	4.01	6.99	9.16	10.82
35	1.99	4.02	6.98	9.11	10.64
40	1.98	4.03	6.97	9.06	10.46
45	1.98	4.04	6.97	9.03	10.28
50	1.98	4.06	6.97	8.99	10.10

MERCK (Ref. 20°C)

T [°C]	2.00	4.00	7.00	9.00	12.00
5	2.01	4.04	7.07	9.16	12.41
10	2.01	4.02	7.05	9.11	12.26
15	2.00	4.01	7.02	9.05	12.10
20	2.00	4.00	7.00	9.00	12.00
25	2.00	4.01	6.98	8.95	11.88
30	2.00	4.01	6.98	8.91	11.72
35	2.00	4.01	6.96	8.88	11.67
40	2.00	4.01	6.95	8.85	11.54
45	2.00	4.01	6.95	8.82	11.44
50	2.00	4.00	6.95	8.79	11.33

JIS Z 8802 (Ref. 25°C)

T [°C]	1.679	4.008	6.865	9.180
5	1.668	3.999	6.951	9.395
10	1.670	3.998	6.923	9.332
15	1.672	3.999	6.900	9.276
20	1.675	4.002	6.881	9.225
25	1.679	4.008	6.865	9.180
30	1.683	4.015	6.853	9.139
35	1.688	4.024	6.844	9.102
40	1.694	4.035	6.838	9.068
45	1.700	4.047	6.834	9.038
50	1.707	4.060	6.833	9.011

DIN(19266) NIST (Ref. 25°C)

T [°C]	1.68	4.008	6.865	9.183	12.454
5	1.668	4.004	6.950	9.392	13.207
10	1.670	4.001	6.922	9.331	13.003
15	1.672	4.001	6.900	9.277	12.810
20	1.676	4.003	6.880	9.228	12.627
25	1.680	4.008	6.865	9.183	12.454
30	1.685	4.015	6.853	9.144	12.289
35	1.691	4.026	6.845	9.110	12.133
40	1.697	4.036	6.837	9.076	11.984
45	1.704	4.049	6.834	9.046	11.841
50	1.712	4.064	6.833	9.018	11.705

DIN(19267) (Ref. 25°C)

T [°C]	1.09	4.65	6.79	9.23	12.75
5	1.08	4.67	6.87	9.43	13.63
10	1.09	4.66	6.84	9.37	13.37
15	1.09	4.66	6.82	9.32	13.16
20	1.09	4.65	6.80	9.27	12.96
25	1.09	4.65	6.79	9.23	12.75
30	1.10	4.65	6.78	9.18	12.61
35	1.10	4.65	6.77	9.13	12.45
40	1.10	4.66	6.76	9.09	12.29
45	1.10	4.67	6.76	9.04	12.09
50	1.11	4.68	6.76	9.00	11.98

JJG119 (Ref. 25°C)

T [°C]	1.680	4.003	6.864	9.182	12.460
5	1.669	3.999	6.949	9.391	13.210
10	1.671	3.996	6.921	9.330	13.011
15	1.673	3.996	6.898	9.276	12.820
20	1.676	3.998	6.879	9.226	12.637
25	1.680	4.003	6.864	9.182	12.460
30	1.684	4.010	6.852	9.142	12.292
35	1.688	4.019	6.844	9.105	12.130
40	1.694	4.029	6.838	9.072	11.975
45	1.700	4.042	6.834	9.042	11.828
50	1.706	4.055	6.833	9.015	11.697

Technical (Ref. 25°C)

T [°C]	2.00	4.01	7.00	10.00
5	2.01	4.01	7.09	10.65
10	2.00	4.00	7.06	10.39
15	2.00	4.00	7.04	10.26
20	2.00	4.00	7.02	10.13
25	2.00	4.01	7.00	10.00
30	1.99	4.01	6.99	9.87
35	1.99	4.02	6.98	9.74
40	1.98	4.03	6.97	9.61
45	1.98	4.04	6.97	9.48
50	1.98	4.06	6.97	9.35

To protect your product's future:

METTLER TOLEDO Service assures the quality, measuring accuracy and preservation of value of this product for years to come.

Please request full details about our attractive terms of service.

www.mt.com/ph

For more information

Mettler-Toledo AG, Analytical

CH-8603 Schwerzenbach, Switzerland

Tel. +41 (0)44 806 77 11

Fax +41 (0)44 806 73 50

www.mt.com

Subject to technical changes.

© Mettler-Toledo AG 08/2014

30219773A

