

User Guide for 3 axis TB6560 driver board

เป็นสินค้าจากประเทศจีน ที่มีจุดเด่นของ DRIVER BOARD ของ Toshiba TB6560AHQ chip ตามรายละเอียด

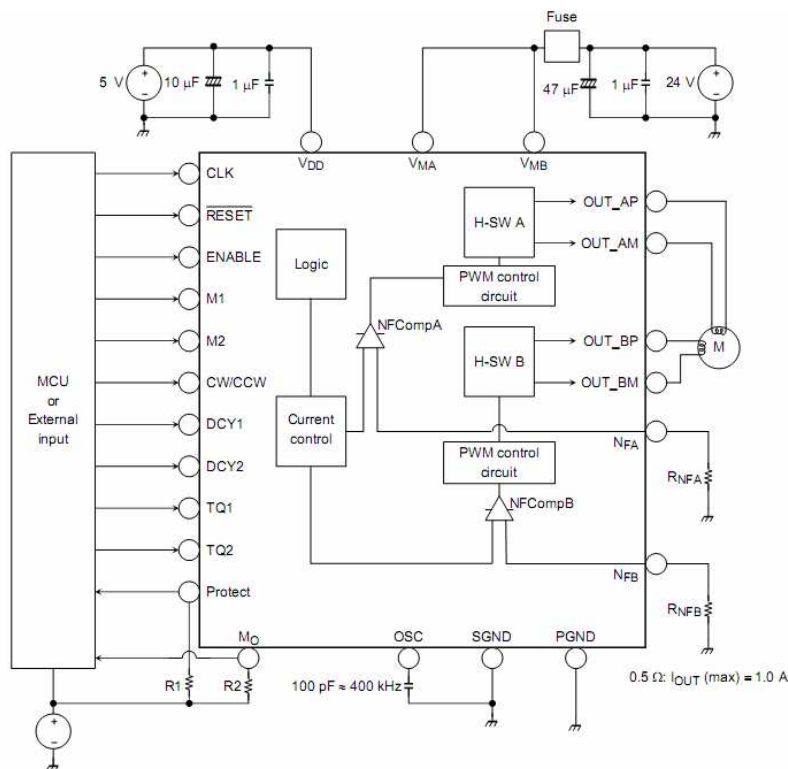

Block Diagram Toshiba TB6560AHQ chip

Product Features:

- 1. Toshiba TB6560AHQ chip** - High power, maximum 3A (peak value 3.5A) drive current chipset !
- 2. Micorstep** 1-1/16 micro step setting - Higher accuracy and smoother operation than standard 1, 1/2 step!
- 3. current settings** Adjustable drive current settings for each axis - 25%,50%,75%,100% of full current can be set for different stepper motors
- 4. Overload** over-current and over-temperature safety - Full protection for your computer and peripheral equipment !
- 5. On board current switching** - Power output can be set according to specific user requirement !
- 6. Full closed-type optical isolation** to protect the user's computer and equipment
- 7. Relay spindle interface-Outputs** Max. 36V 7.5A for spindle motors or coolant pump (only one device can be powered by this output!)
- 8. 4channel inputs interface** Can be used for XYZ limit and emergency stop !(Input 1,2,3,4)
- 9. Professional design** Two stage signal processing with super anti-jamming !
- 10. Bipolar constant current** chopper drive with non-resonant region - Controls motors smoothly through range without creep effect !
- 11. Universal architecture** Supports most parallel software MACH3, KCAM4, EMC2 etc!

* Important Notes:

Power supply DC 12-36V (not included)

*Voltage Selection:

12-16V DC power supply for Nema 17 stepper motors
 16-24V DC power supply for Nema 23 stepper motors
 24-36V DC power supply for Nema 34 stepper motors
 (High voltage will burn up the chips or stepper motors!!!)

***Ampertage Selection:**

Output current of the power supply can be calculated by the following expressions:

Output current = Rated current of your stepper motors * quantity + 2A

(For example, if you want to drive 3 * 3A Nema 23 stepper motors, theoretically 24V 11A DC power supply is recommended, but higher power such as 24V 15A also will be good.

If you are not sure about the selection of power supply, please feel free to contact us for help)

The power output of 12V shall be applied to the radiator fan of 12V

Driver output compatible with 2 or 4 phase, 4,6 or 8 lead stepper motors, 3A max.

Voltage regulated spindle speed controlled by parallel interface as function of supply voltage.

Wiring Diagram:

The diagram shows five wiring configurations for stepper motors:

- 4 Leads:** A+ and A- on the top coil, B+ and B- on the bottom coil.
- 6 Leads High Torque:** A+ and A- on the top coil, B+ and B- on the bottom coil, with a center tap (NC) on the bottom coil.
- 6 Lead High Speed:** A+ and A- on the top coil, B+ and B- on the bottom coil, with a center tap (NC) on the top coil.
- 8 Leads Series - wound High Torque:** +A and -A on the top coil, +B and -B on the bottom coil.
- 8 Leads Shunt - wound High Speed:** +A and -A on the top coil, +B and -B on the bottom coil.

Below the diagrams is a graph of TORQUE vs SPEED. It shows three curves: BIPOLAR SERIES (highest torque), BIPOLAR PARALLEL (middle torque), and UNIPOLAR & HALF COIL (lowest torque).

Serial & parallel Wiring Diagram For select Speed & Torque

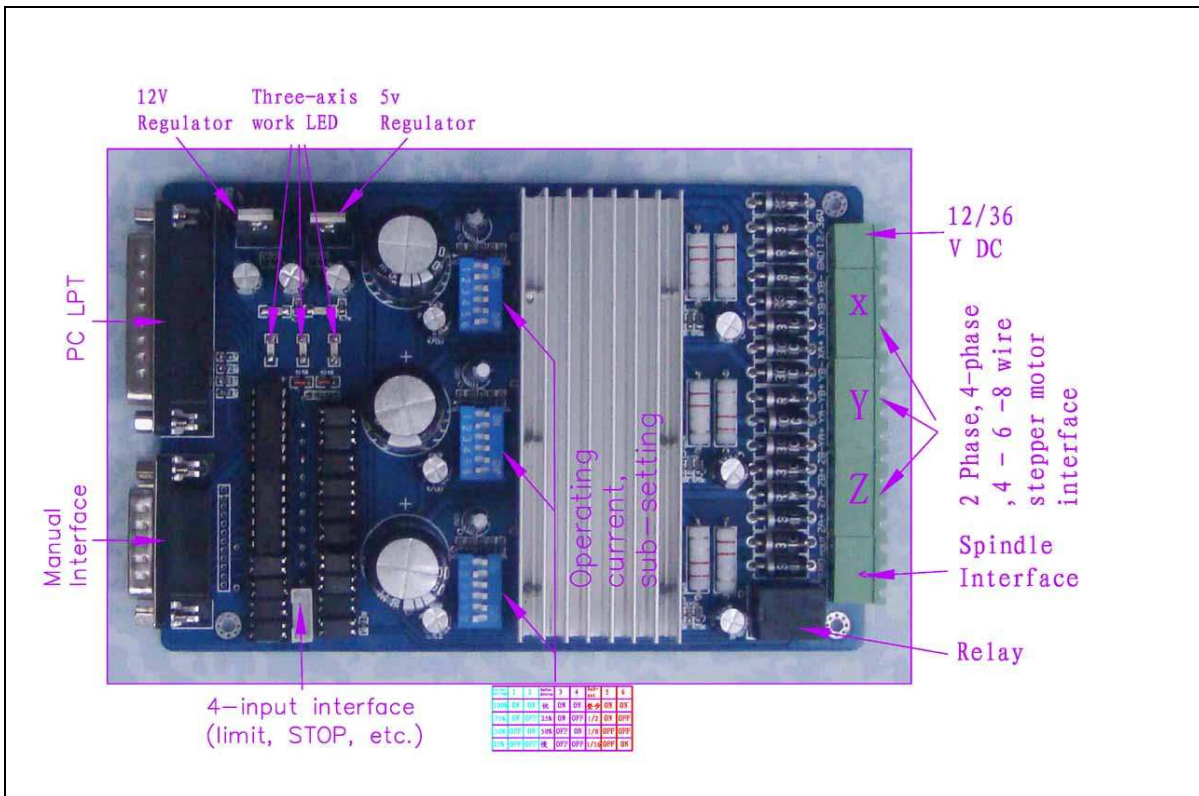

Dip settings:

Current Setting	1	2	Decay Mode Settings	3	4	MicroStep Settings	5	6
100%	ON	ON	FAST	ON	ON	1	ON	ON
75%	ON	OFF	25%	ON	OFF	1/2	ON	OFF
50%	OFF	ON	50%	OFF	ON	1/8	OFF	OFF
25%	OFF	OFF	SLOW	OFF	OFF	1/16	OFF	ON

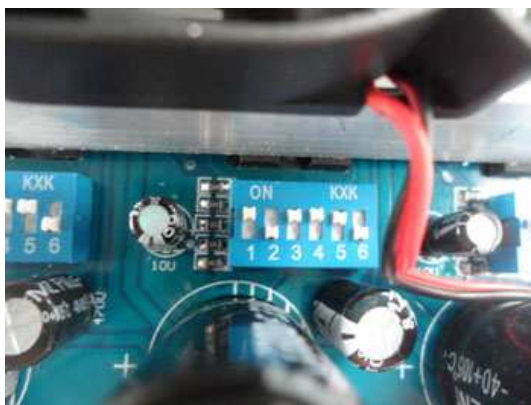

Dip Switch

The definition of 1-PIN 25 of Parallel Interface:

PIN 9	PIN14	PIN7	PIN1	PIN2	PIN3	PIN8	PIN6	PIN4	PIN5	PIN16	PIN17
-------	-------	------	------	------	------	------	------	------	------	-------	-------

spindle motor	X Enable	X Dir	X Step	Y Enable	Y Dir	Y Step	Z Enable	Z Dir	Z Step	Expand output 1	Expand output2
---------------	----------	-------	--------	----------	-------	--------	----------	-------	--------	-----------------	----------------

The definition of 4 channel inputs interface:

PIN 13	PIN 10	PIN 11	PIN 12
Input1 (E-STOP)	Input2(Limit&Home X)	Input3(Limit&Home Y)	Input4(Limit&Home Z)

The definition of 1-PIN15 of Manual Interface:

P1	P2	P3	P4	P5	P6	P7	P8	P9	P10	P11	P12	P13	P14	P15
X Step	X Enable	Spindle Motor	X Dir	Y Enable	Z Dir	Z Step	Z Enable	Y Limit	Z Limit	Y Dir	Y Step	STOP	GND	5v/VDD

Configuration Output Step & Dir X,Y ,Z

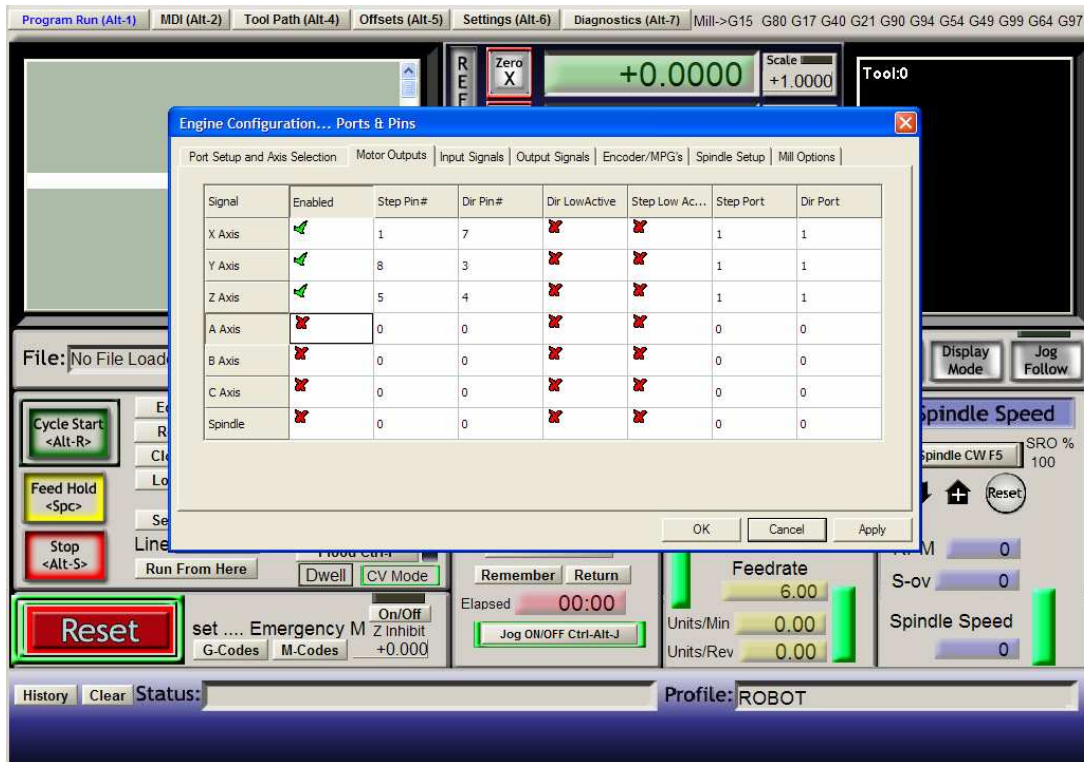

Configuration Output Enable 1-3(X,Y ,Z) pin 14,2,6 & Output#1 pin 9 For Spindle Motor (M3)

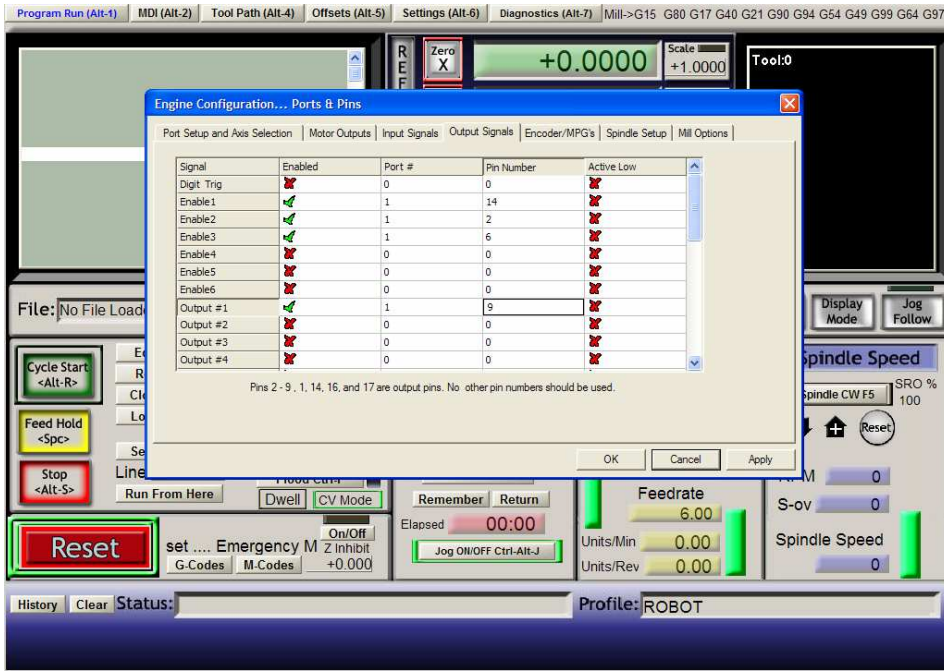

Enable Spindle Relay & select Clockwise (M3) Output#1

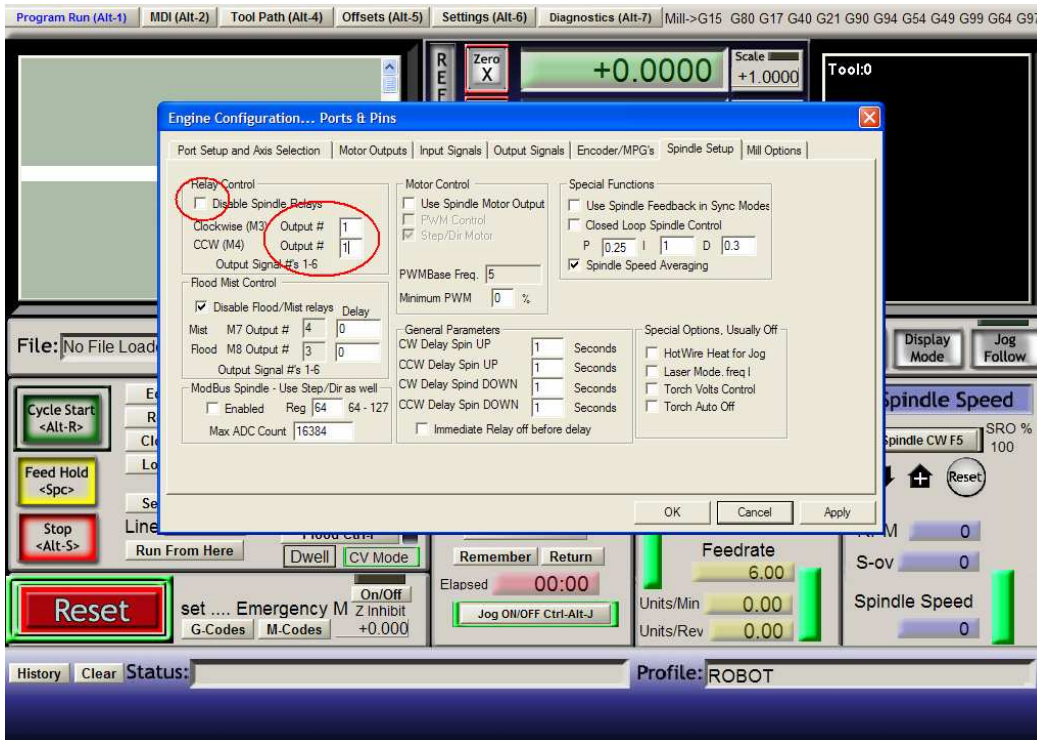

Limit setting & Home X,Y,Z Pin10, 11,12

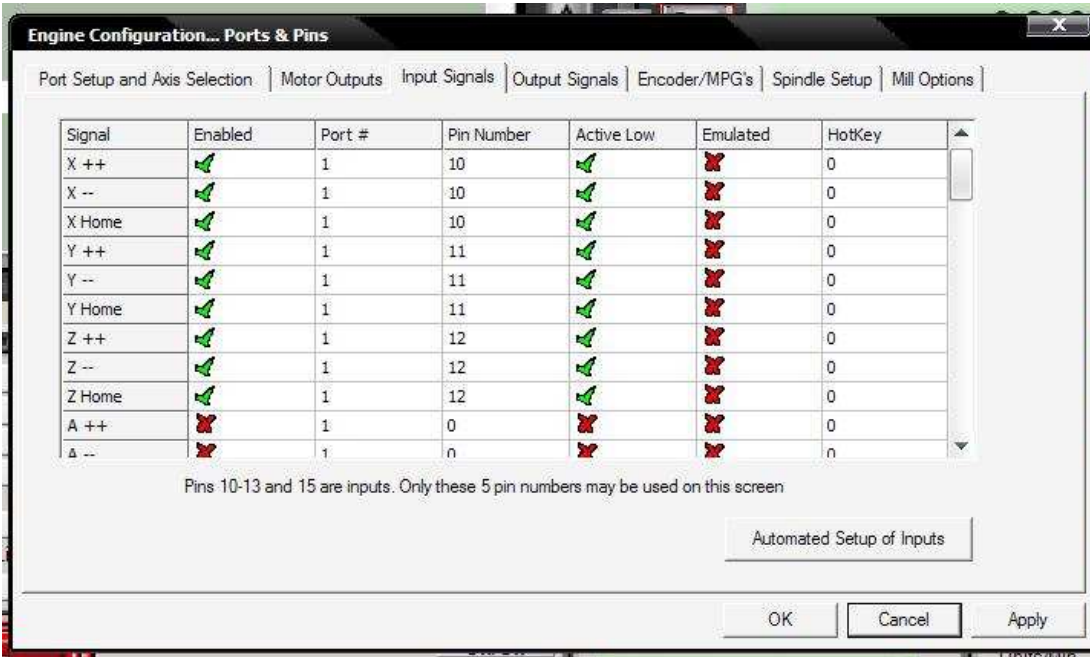

E-stop Pin 13

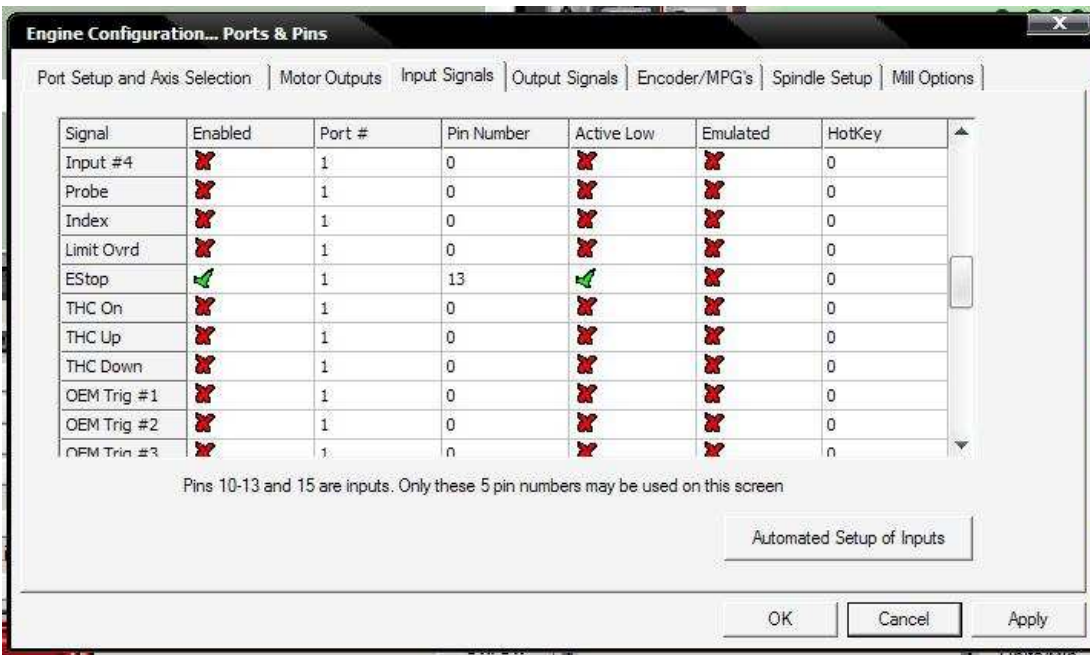

Limit setting & Home X,Y,Z Pin 11,12,13

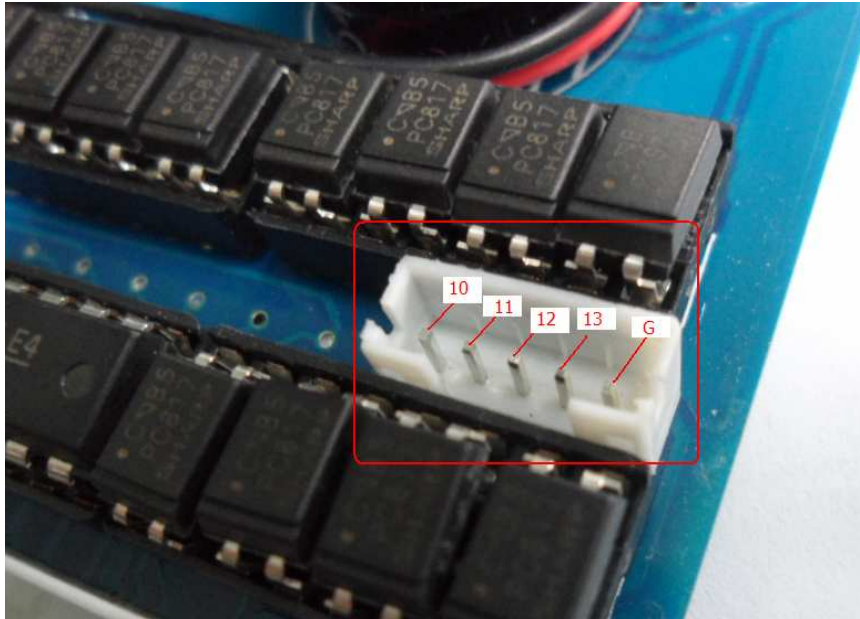

- Pin 10 Limit+,- & Home X Connect with Ground (G)
 Pin 11 Limit +,- & Home Y Connect with Ground(G)
 Pin 12 Limit +,- & Home Z Connect with Ground(G)
 Pin 13 E-Stop Connect with Ground(G)

Use Auto Setup Of Input Signals

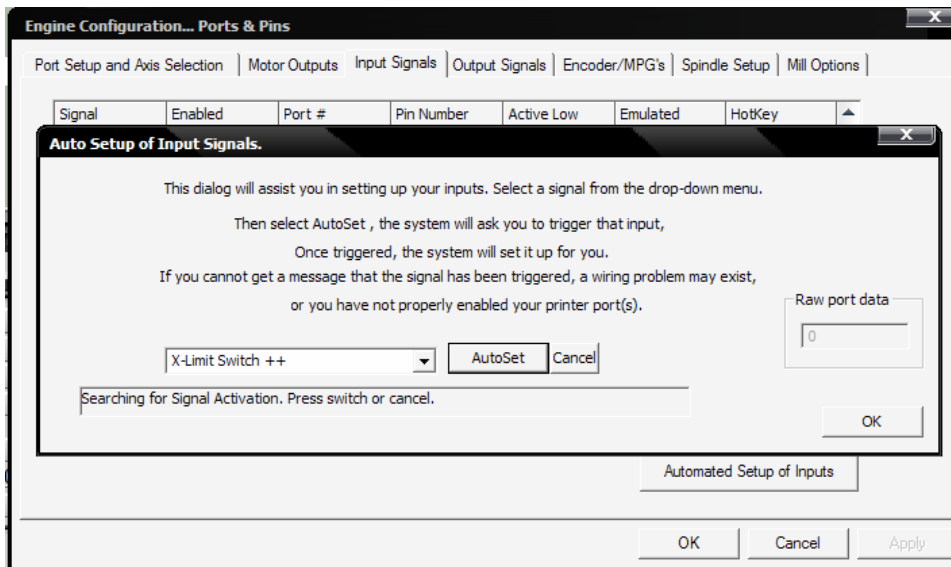

The definition of output Interface:

Pin1	Pin2	Pin3	Pin4	Pin5	Pin6	Pin7	Pin8	Pin9	Pin 10	Pin 11	Pin 12	Pin 13	Pin 14	Pin 15	Pin 16	Pun 17
VDD	G	XB-	XB+	XA-	XA+	YB-	YB+	YA-	YA+	ZB-	ZB+	ZA-	ZA-	Lela yNO	G	Lela yNc

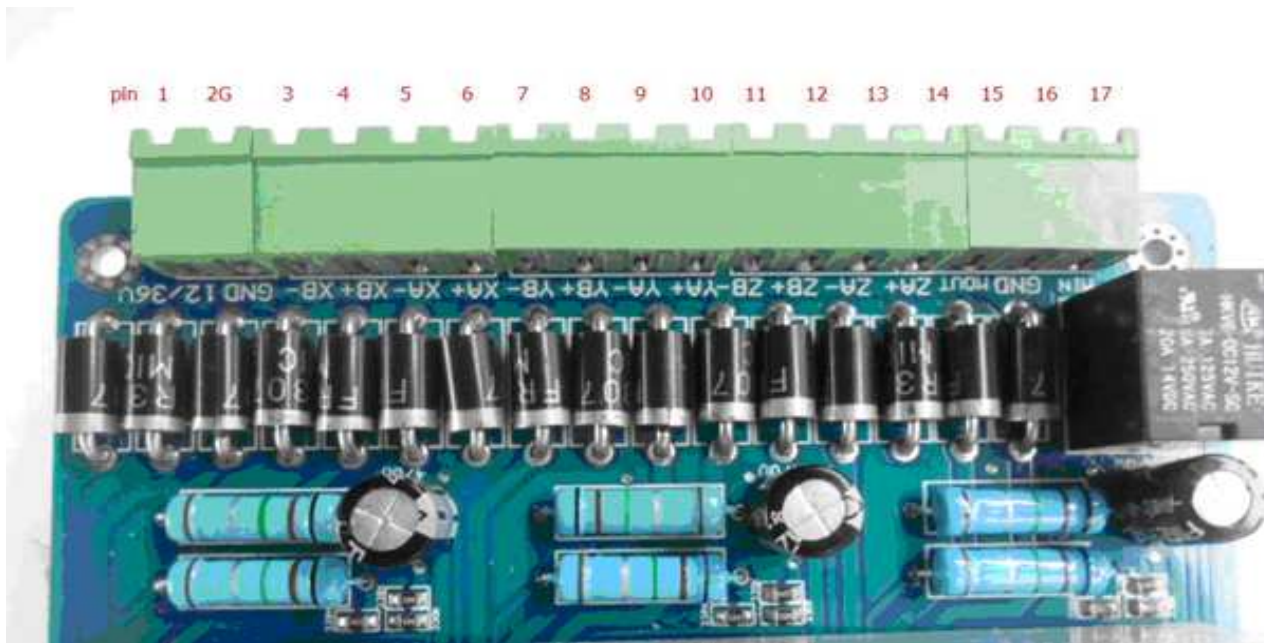

Output pin 16 ,17

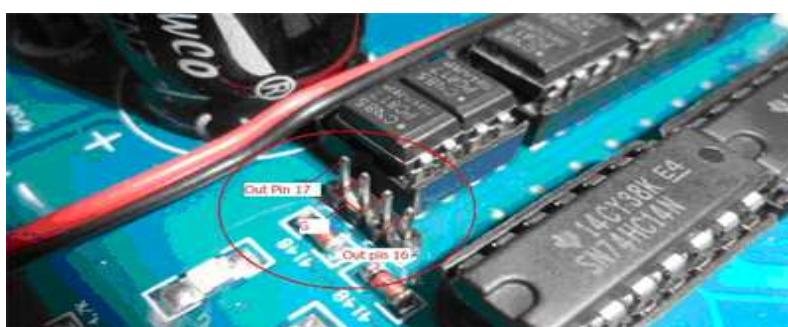

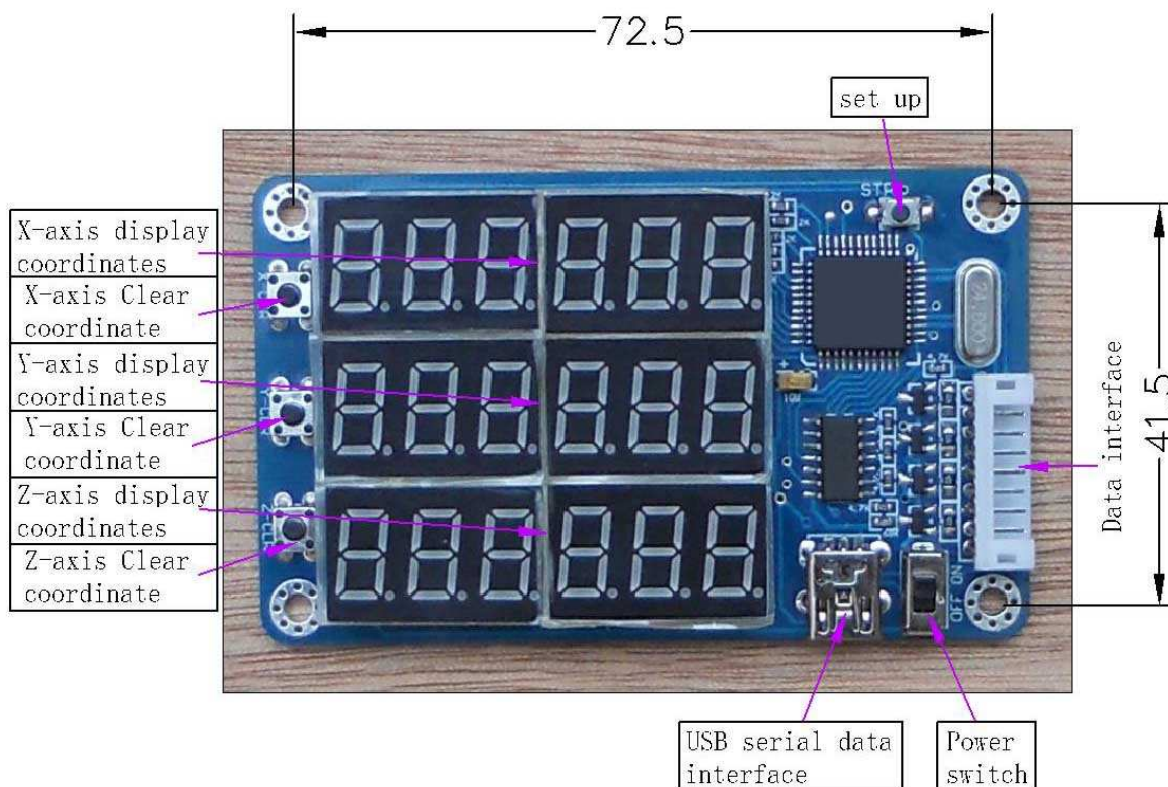

This product comes standard with HY-TB3DV-M driver board, using the appropriate cable docking HY-TB3DV-M driver board corresponding to digital interface, digital products obtained directly from the drive plate into the 5V power supply, no external power supply is

Steps

A: Use the appropriate cable docking HY-TB3DV-M driver board and then open the corresponding digital display interface, power switch, 3-axis digital display origin 0

B: Set each axis 0. 1MM amount required pulse

1: Press Setup (STP) button, 3-axis digital display flashing display area, said the state has entered the set

2: Press the 0 key to clear the corresponding bit axis, the corresponding axis display area plus 1 to 0. 1MM value of the required amount of stop pulse.

3: Press Set (STP) button, 3-axis digital display area without blinking, that is set OK, exit the setting mode, display the status of work into

C: 3-axis display real-time display synchronized 3-axis coordinate value

D: display status of work to 0 by the corresponding axis key, the corresponding axis display coordinates to 0

Connection example pictures

Setting an example: If the X-axis 0. 1MM pulse required is equal 10, Y-axis 0. 1MM pulse required is equal 20, Z axis 0. 1MM pulse volume equal to the required 30.

1: Press Setup (STP) button, display blinking, into the set state

2: X-axis under the key 10 to 0, X-axis digital value equal to 10

3: Press the Y axis to 0 under the key 20, Y-axis digital value equal to 20

3: Z-axis to 0 by the next key 30, Z-axis digital value equal to 30

- 4: Press Setup (STP) key, display stops flashing to exit the setting mode
- 5: Setting success. Will automatically set the parameters permanently stored until the next set will be refreshed after the success of setting parameters

Manual Control Manual

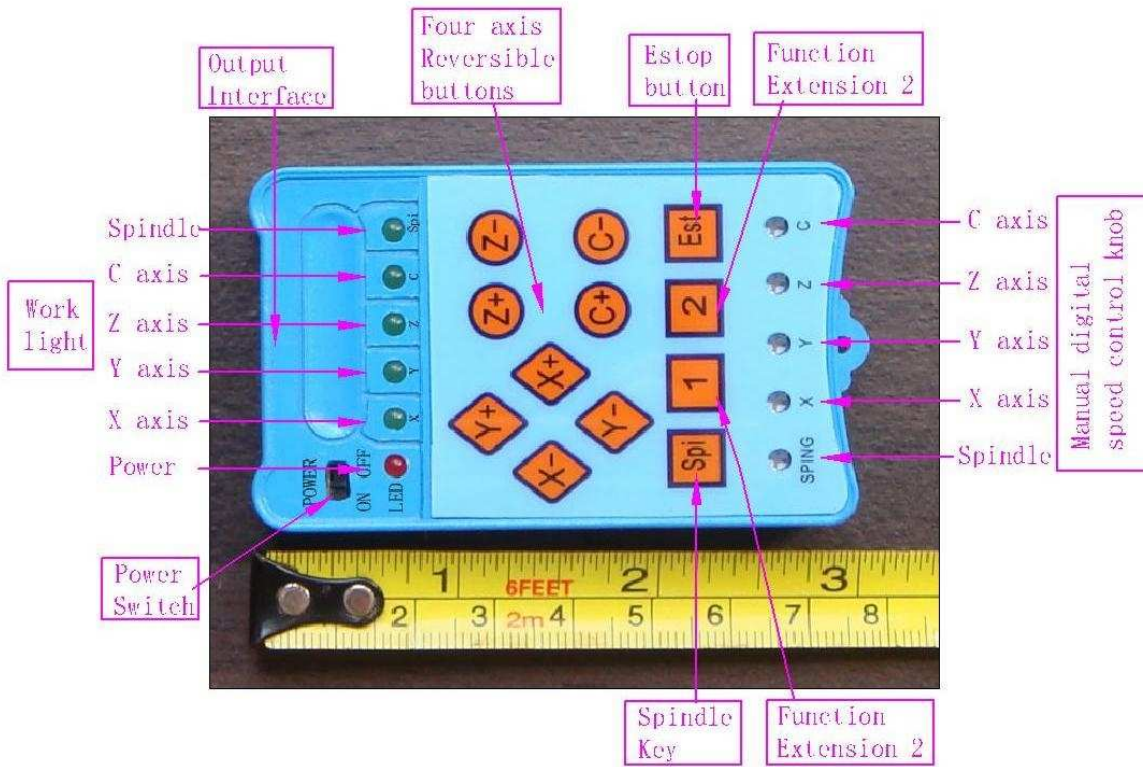

15P connector at both ends of the corresponding Definitions

1	2	3	4	5	6	7	8	9	10	11	12	13	14
Black	Palm	Red	Orange	Yellow	Green	Blue	Purple	Gray	White	Powder	Light green	Black/White	Palm/Wh

Handle the output interface definition

1	2	3	4	5	6	7	8	9	10	11	12	13	14
5V/V DD	GND	Esto p	Emp ower 1	Emp ower 2	Spin dle	X/Dir	X/Ste p	Y/Dir	Y/Ste p	Z/Dir	Z/Ste p	C/Dir	C/Ste p

HY-TB3DV-M axis drive board manual interface definition

Black	Palm	Red	Orange	Yellow	Green	Blue	Purple	Gray	White	Powder	Light green	Black/White	Palm/White	Red/White
P1	P2	P3	P4	P5	P6	P7	P8	P9	P10	P11	P12	P13	P14	P15
X/Step	X/Empower	Spindle	X/Dir	Y/Empower	Z/Dir	Z/Step	Z/Empower	5V/VDD	GND	Estop	Y/Step	Y/Dir	Z/Limit	Y/Limit

HY-TB4DV-M four-axis drive board manual interface definition

Black	Palm	Red	Orange	Yellow	Green	Blue	Purple	Gray	White	Powder	Light green	Black/White	Palm/White	Red/White
P1	P2	P3	P4	P5	P6	P7	P8	P9	P10	P11	P12	P13	P14	P15
Z/CEmpower	C/Step	Z/Step	X/Dir	X/Empower	Y/Empower	Y/Dir	Z/Dir	5V/VDD	GND	Estop	X/Step	Y/Step	Spindle	C/Dir

四》 HY-TB5DV-M axis drive board manual interface definition

Black	Palm	Red	Orange	Yellow	Green	Blue	Purple	Gray	White	Powder	Light green	Black/White	Palm/White	Red/White
P1	P2	P3	P4	P5	P6	P7	P8	P9	P10	P11	P12	P13	P14	P15
总Empower	C/Step	Z/Step	X/Step	X/Dir	Y/Dir	Z/Dir	C/Dir	5V/VDD	GND	Estop	Y/Step	D/Step	Spindle	DDir

TA4 handle axis defined

Black	Palm	Red	Orange	Yellow	Green	Blue	Purple	Gray	White	Powder	Light green	Black/White	Palm/White	Red/White
P1	P2	P3	P4	P5	P6	P7	P8	P9	P10	P11	P12	P13	P14	P15
Spindle	A/Dir	B/Dir	B/Empower	C/Step	D/Dir	C/Dir	A/Empower	5V/VDD	GND	GND	D/Step	B/Step	C/允许	A/Step

Interface board handles the definition of

Black	Palm	Red	Orange	Yellow	Green	Blue	Purple	Gray	White	Powder	Light green	Black/White	Palm/White	Red/White
P1	P2	P3	P4	P5	P6	P7	P8	P9	P10	P11	P12	P13	P14	P15

C/Di r	C/ Step	X/ Step	X/Di r	Y/Di r	Z/Di r	Spin dle	Expa nd	5V/V DD	GND	Esto p	Y/ Step	Z/ Step	E1	E2
-----------	------------	------------	-----------	-----------	-----------	-------------	------------	------------	-----	-----------	------------	------------	----	----

Instructions

- 1: The first drive with a corresponding docking connector board good driver board
- 2: turn on the power switch, power indicator light
- 3: Click the corresponding axis manual control buttons, the corresponding stepper motor shaft rotation axis while the corresponding indicator light, release the button to stop stepping motor
- 4: Manually adjust the speed dial number is about 300 degrees rotation within the (limited spaces on both sides of the fixed position), clockwise rotation acceleration, deceleration counterclockwise rotation,